

| | | |
|-------|-------|------|
| 1: | 10.1 | ↑ |
| 2: | 10.1 | ← |
| 3: | *10.8 | ↙ |
| 4: | 10.2 | ↘ |
| 5: | 9.6 | ↘ |
| 6: | 9.9 | → |
| 7: | 9.8 | ↘ |
| 8: | *10.7 | ↘ |
| Serie | | 77.0 |
| Total | | 0.0 |

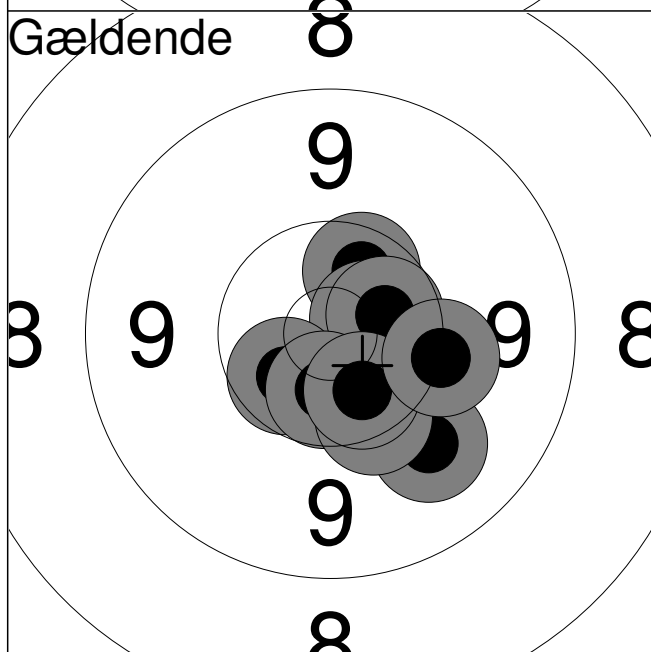

| | | |
|-------|-------|------|
| 1: | *10.5 | ↑ |
| 2: | *10.7 | → |
| 3: | *10.5 | ↙ |
| 4: | 9.9 | ↘ |
| 5: | *10.5 | ↘ |
| 6: | *10.5 | → |
| 7: | *10.6 | ↘ |
| 8: | 10.3 | ↘ |
| 9: | *10.5 | ↘ |
| 10: | 10.2 | → |
| Serie | | 99.0 |
| Total | | 99.0 |

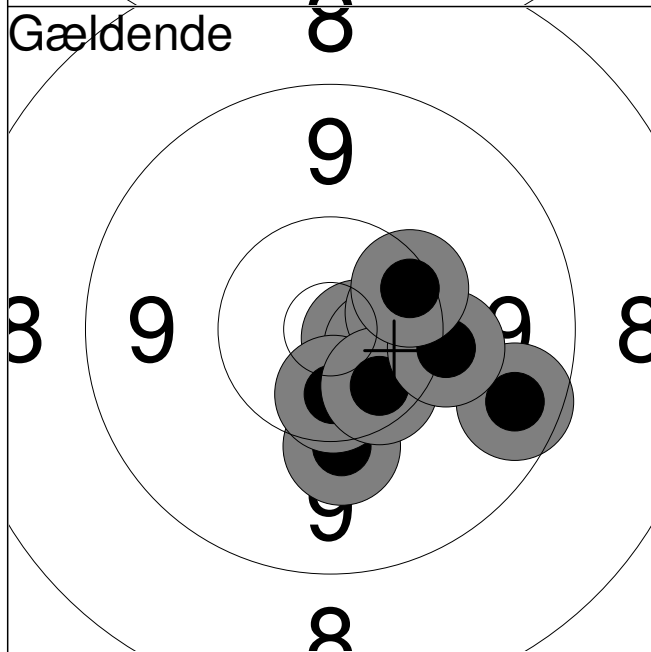

| | | |
|-------|-------|-------|
| 11: | *10.7 | → |
| 12: | 10.3 | → |
| 13: | *10.6 | ↘ |
| 14: | 10.1 | ↙ |
| 15: | 9.5 | ↘ |
| 16: | *10.5 | ↙ |
| 17: | *10.4 | → |
| 18: | *10.4 | ↙ |
| 19: | 10.1 | → |
| 20: | 10.3 | → |
| Serie | | 99.0 |
| Total | | 198.0 |

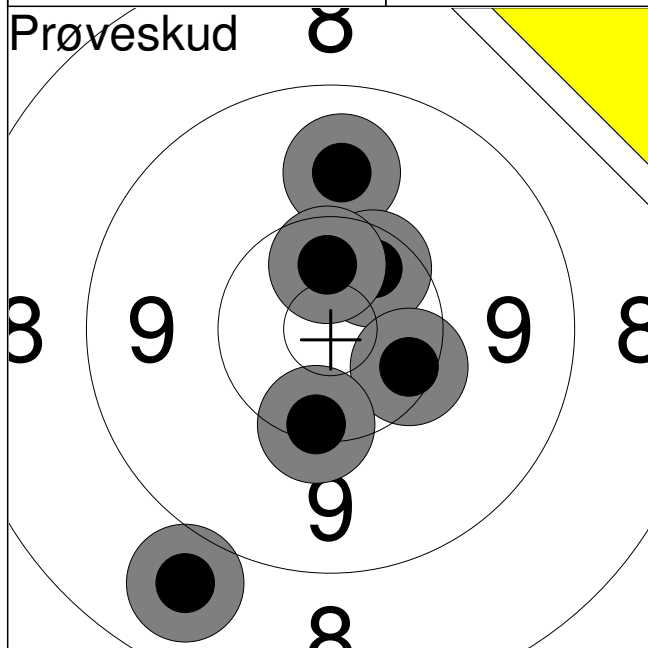

| | | |
|----|-------|---|
| 1: | 9.8 | ↑ |
| 2: | *10.4 | ↗ |
| 3: | 8.8 | ↘ |
| 4: | 10.3 | → |
| 5: | 10.3 | ↓ |
| 6: | *10.5 | ↑ |

| | |
|-------|------|
| Serie | 57.0 |
| Total | 0.0 |

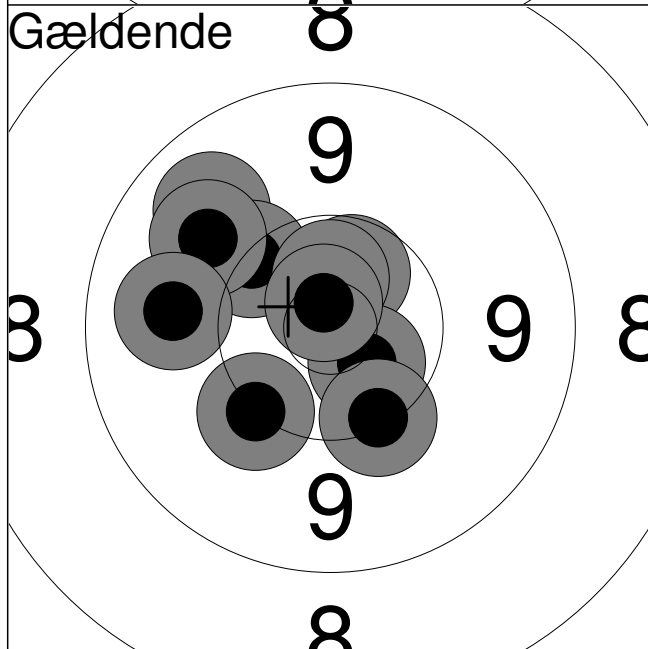

| | | |
|-----|-------|---|
| 1: | 9.8 | ↗ |
| 2: | 10.2 | ↗ |
| 3: | *10.5 | ↗ |
| 4: | *10.6 | ↘ |
| 5: | 10.2 | ↘ |
| 6: | 10.2 | ↘ |
| 7: | *10.6 | ↑ |
| 8: | 9.9 | ↗ |
| 9: | 9.8 | ← |
| 10: | *10.8 | ↑ |

| | |
|-------|------|
| Serie | 97.0 |
| Total | 97.0 |

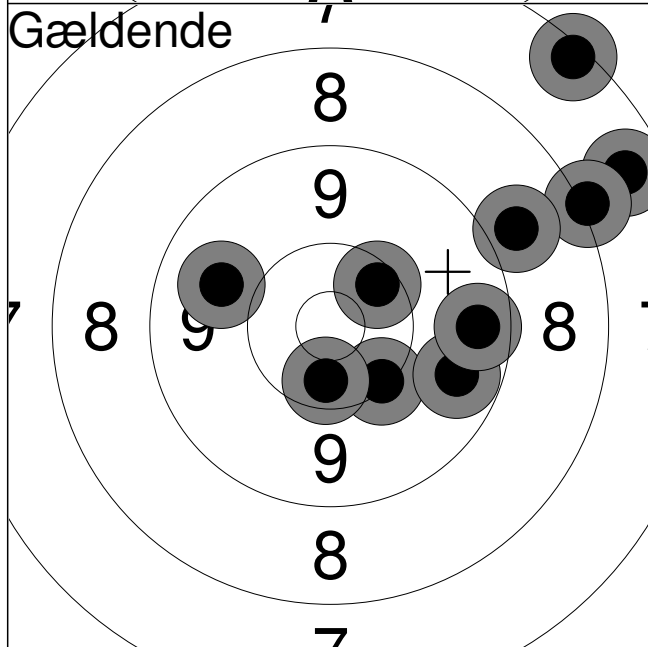

| | | |
|-----|-------|---|
| 11: | 7.6 | ↗ |
| 12: | 7.3 | ↗ |
| 13: | 9.8 | ← |
| 14: | 10.2 | ↘ |
| 15: | *10.4 | ↓ |
| 16: | 8.1 | ↗ |
| 17: | 10.4 | ↗ |
| 18: | 8.9 | ↗ |
| 19: | 9.6 | → |
| 20: | 9.5 | → |

| | |
|-------|-------|
| Serie | 87.0 |
| Total | 184.0 |

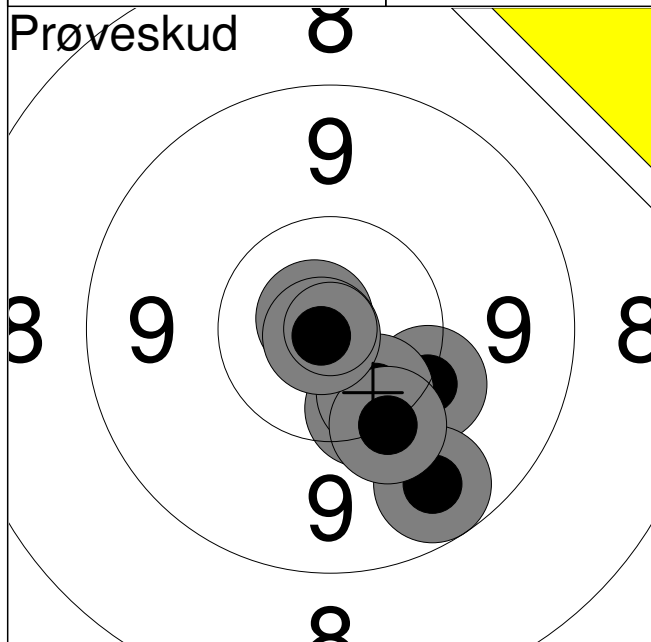

| | | |
|----|-------|---|
| 1: | 10.3 | ↓ |
| 2: | *10.8 | ↗ |
| 3: | 10.2 | ↓ |
| 4: | 10.4 | ↓ |
| 5: | 9.6 | ↓ |
| 6: | 10.2 | ↓ |
| 7: | *10.9 | ↙ |

| | |
|-------|------|
| Serie | 69.0 |
| Total | 0.0 |

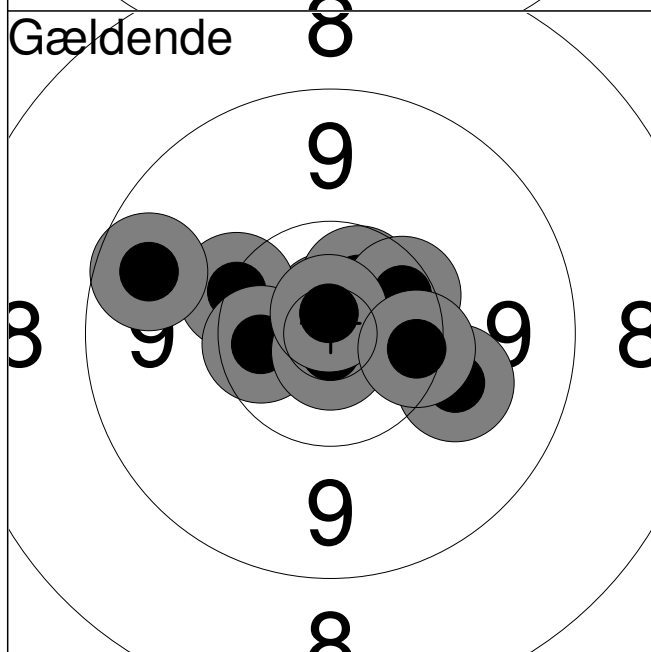

| | | |
|-----|-------|---|
| 1: | *10.8 | ↑ |
| 2: | 10.2 | ↗ |
| 3: | *10.5 | ← |
| 4: | 9.6 | ↗ |
| 5: | 10.0 | ↓ |
| 6: | *10.6 | ↗ |
| 7: | 10.4 | ↗ |
| 8: | *10.8 | ↓ |
| 9: | *10.8 | ↑ |
| 10: | 10.3 | → |

| | |
|-------|------|
| Serie | 99.0 |
| Total | 99.0 |

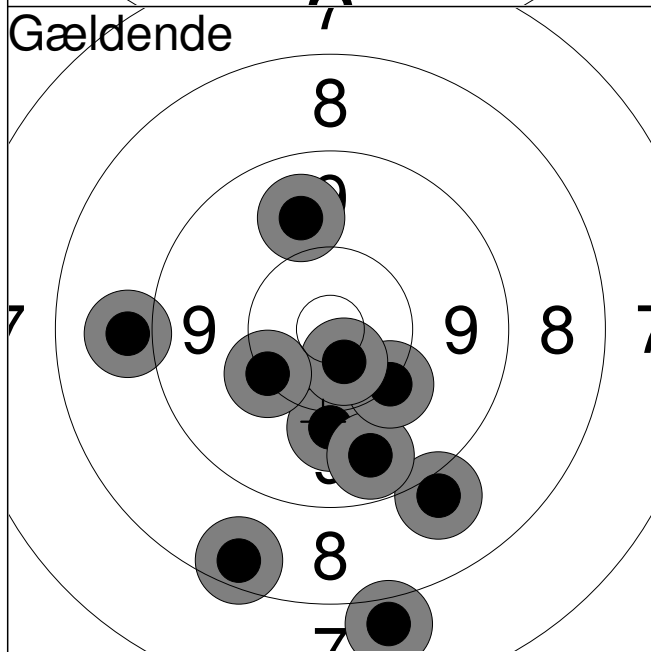

| | | |
|-----|-------|---|
| 11: | 10.0 | ↓ |
| 12: | 8.9 | ← |
| 13: | 9.0 | ↓ |
| 14: | 7.9 | ↓ |
| 15: | 8.4 | ↓ |
| 16: | 9.7 | ↓ |
| 17: | 10.2 | ↓ |
| 18: | *10.6 | ↓ |
| 19: | 9.8 | ↗ |
| 20: | 10.2 | ↙ |

| | |
|-------|-------|
| Serie | 90.0 |
| Total | 189.0 |

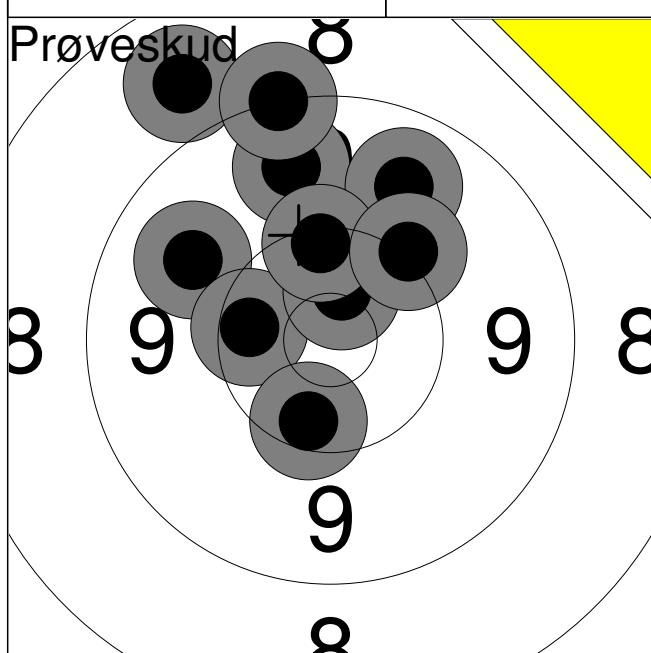

| | | |
|-----|-------|---|
| 1: | 9.8 | ↖ |
| 2: | 8.8 | ↗ |
| 3: | 9.7 | ↗ |
| 4: | 9.2 | ↗ |
| 5: | 9.7 | ↗ |
| 6: | 10.4 | ← |
| 7: | *10.6 | ↗ |
| 8: | 10.3 | ↗ |
| 9: | 10.1 | ↗ |
| 10: | 10.4 | ↓ |

| | |
|-------|------|
| Serie | 94.0 |
| Total | 0.0 |

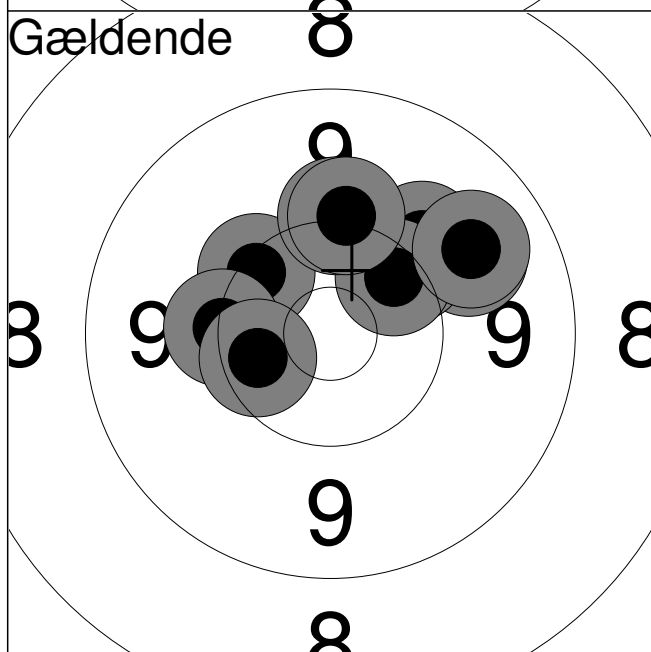

| | | |
|-----|------|---|
| 1: | 9.8 | ↗ |
| 2: | 10.3 | ↖ |
| 3: | 10.2 | ← |
| 4: | 10.2 | ↗ |
| 5: | 10.0 | ↗ |
| 6: | 10.4 | ↗ |
| 7: | 10.1 | ↑ |
| 8: | 10.1 | ↑ |
| 9: | 9.8 | ↗ |
| 10: | 10.4 | ← |

| | |
|-------|------|
| Serie | 98.0 |
| Total | 98.0 |

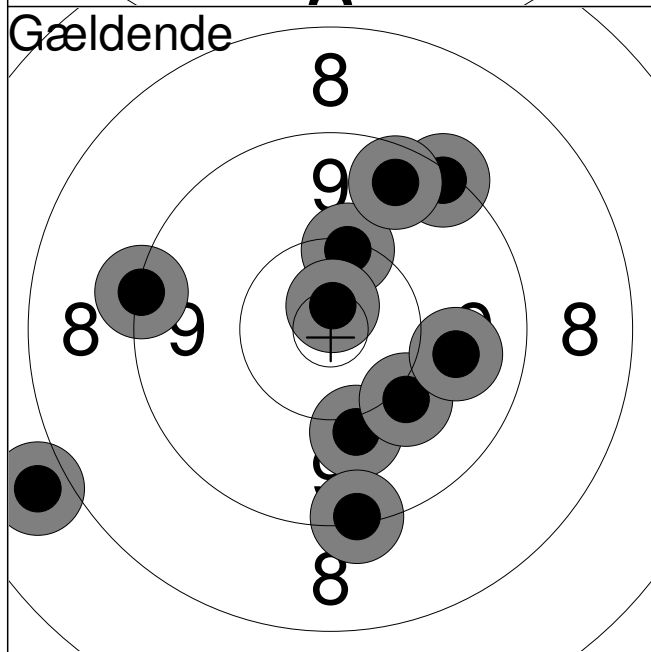

| | | |
|-----|-------|---|
| 11: | 7.9 | ← |
| 12: | 9.3 | ↗ |
| 13: | 10.0 | ↓ |
| 14: | 10.2 | ↑ |
| 15: | 9.2 | ← |
| 16: | 9.2 | ↓ |
| 17: | 10.0 | ↘ |
| 18: | *10.7 | ↑ |
| 19: | 9.8 | → |
| 20: | 9.5 | ↗ |

| | |
|-------|-------|
| Serie | 92.0 |
| Total | 190.0 |

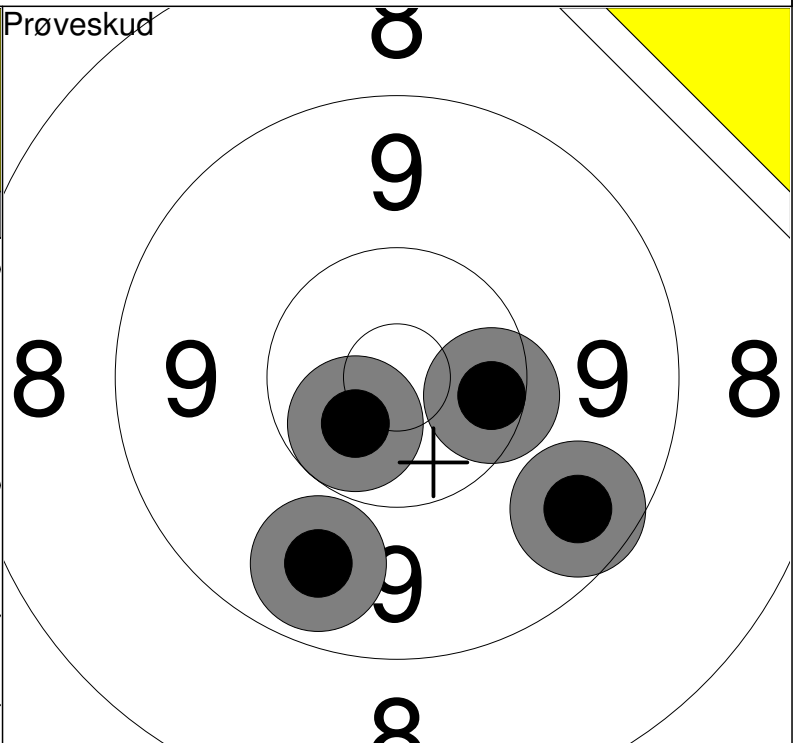
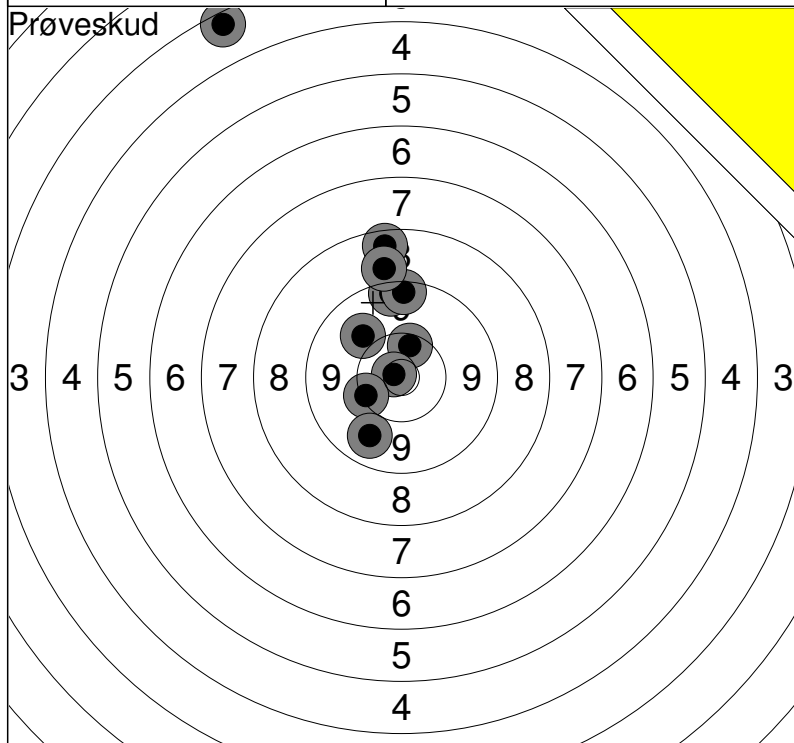

| | | | |
|-----------|------------|-------|----|
| 1: 3.4 ↖ | 6: 8.9 ↑ | Serie | 85 |
| 2: 10.4 ↑ | 7: *10.8 ↖ | | |
| 3: 9.4 ↑ | 8: 10.2 ↖ | Total | 0 |
| 4: 8.5 ↑ | 9: 9.9 ↗ | | |
| 5: 9.4 ↑ | 10: 9.8 ↘ | | |

| | | |
|-------------|-------|----|
| 11: 9.7 ↘ | Serie | 38 |
| 12: 9.6 ↘ | | |
| 13: *10.6 ↘ | Total | 0 |
| 14: 10.4 → | | |

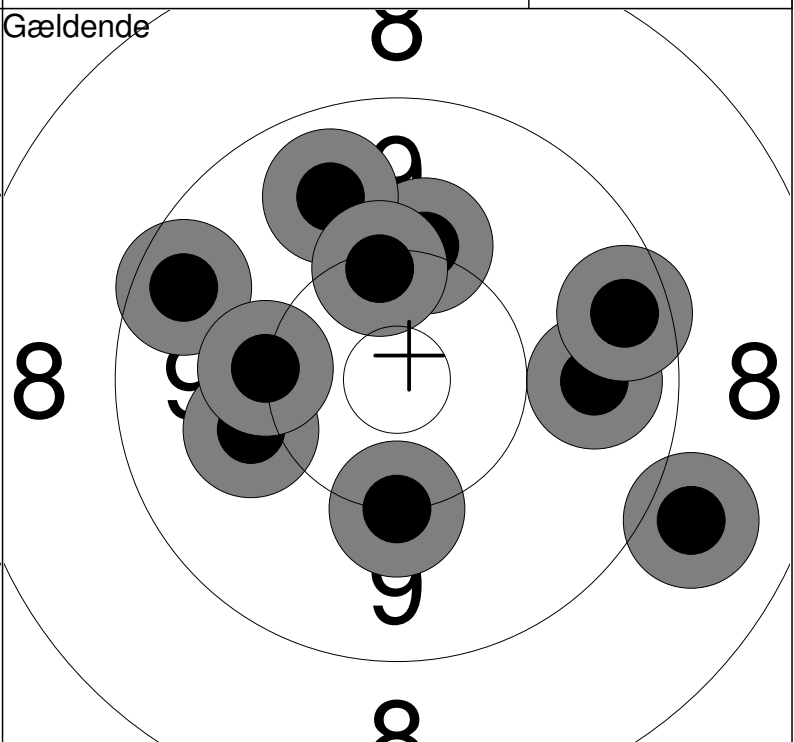
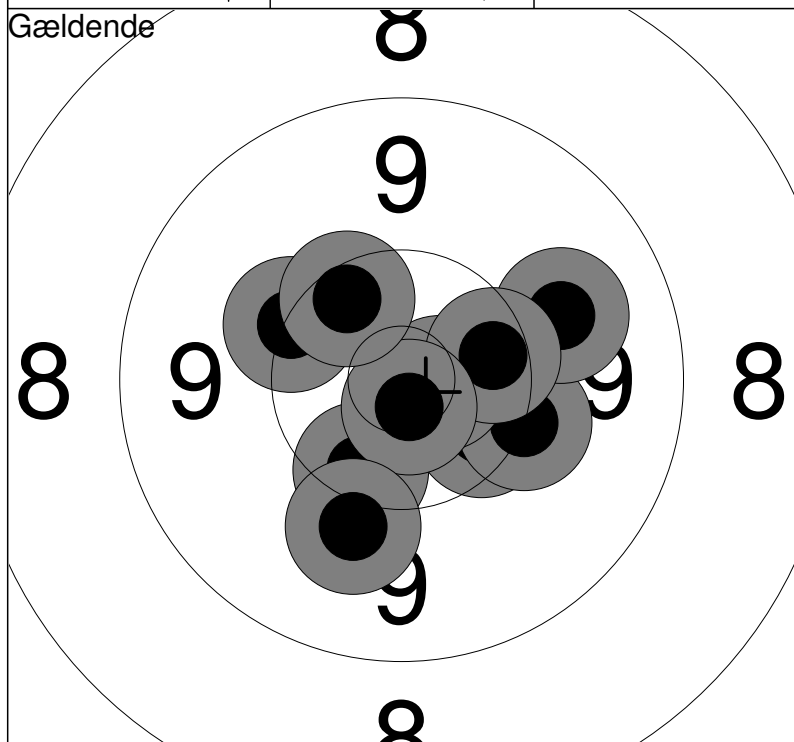

| | | | |
|------------|------------|-------|----|
| 1: 10.4 ↘ | 6: 10.4 → | Serie | 99 |
| 2: 10.3 ↘ | 7: *10.8 ↘ | | |
| 3: 10.2 ↘ | 8: 10.2 ↖ | Total | 99 |
| 4: 9.9 → | 9: 10.0 ↘ | | |
| 5: *10.7 → | 10: 10.4 ↗ | | |

| | | | |
|------------|------------|-------|-----|
| 11: 10.1 ↑ | 16: 9.5 → | Serie | 94 |
| 12: 9.7 ↗ | 17: 9.5 ↖ | | |
| 13: 9.7 → | 18: 10.1 ↖ | Total | 193 |
| 14: 10.0 ↖ | 19: 10.3 ↑ | | |
| 15: 8.9 ↘ | 20: 10.2 ↘ | | |

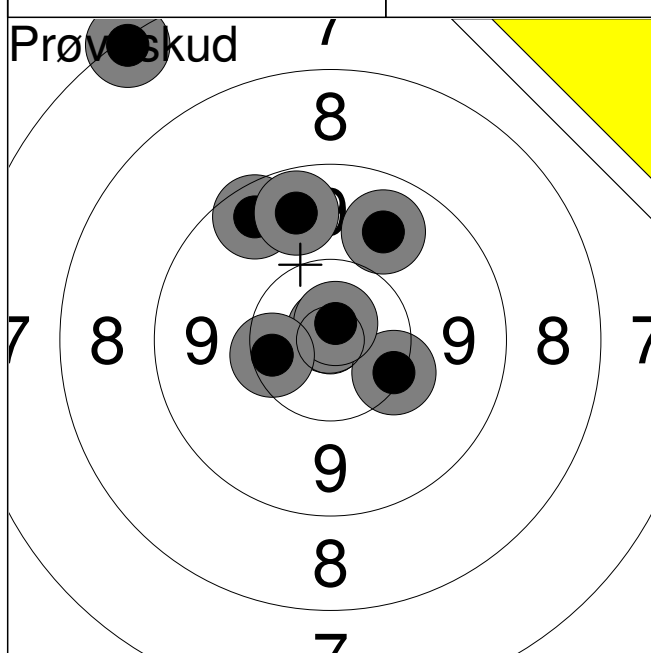

| | | |
|----|-------|---|
| 1: | 7.3 | ↗ |
| 2: | 9.5 | ↗ |
| 3: | 9.6 | ↗ |
| 4: | 9.8 | ↗ |
| 5: | *10.9 | ↗ |
| 6: | 10.3 | ↘ |
| 7: | *10.8 | ↗ |
| 8: | 10.4 | ↖ |

| | |
|-------|------|
| Serie | 74.0 |
| Total | 0.0 |

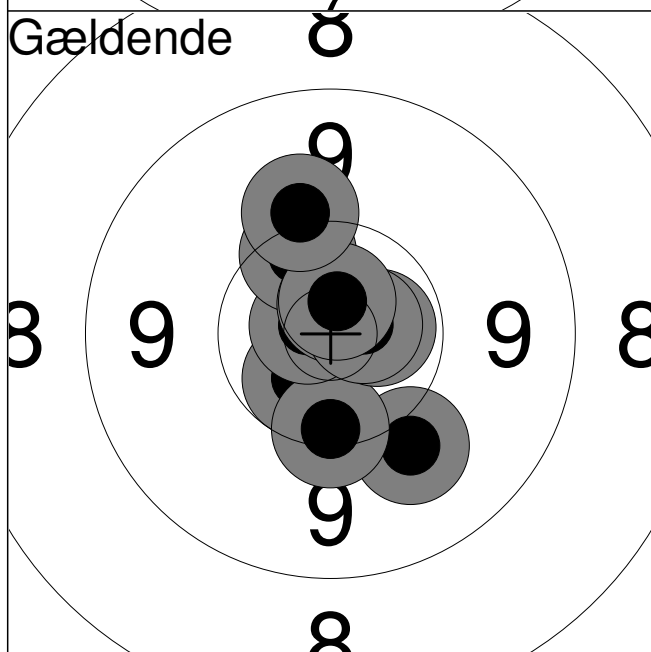

| | | |
|-----|-------|---|
| 1: | 10.0 | ↘ |
| 2: | *10.6 | ↘ |
| 3: | 10.3 | ↘ |
| 4: | *10.8 | ↗ |
| 5: | 10.3 | ↗ |
| 6: | *10.6 | → |
| 7: | *10.7 | ↗ |
| 8: | *10.7 | → |
| 9: | *10.7 | ↗ |
| 10: | 10.1 | ↗ |

| | |
|-------|-------|
| Serie | 100.0 |
| Total | 100.0 |

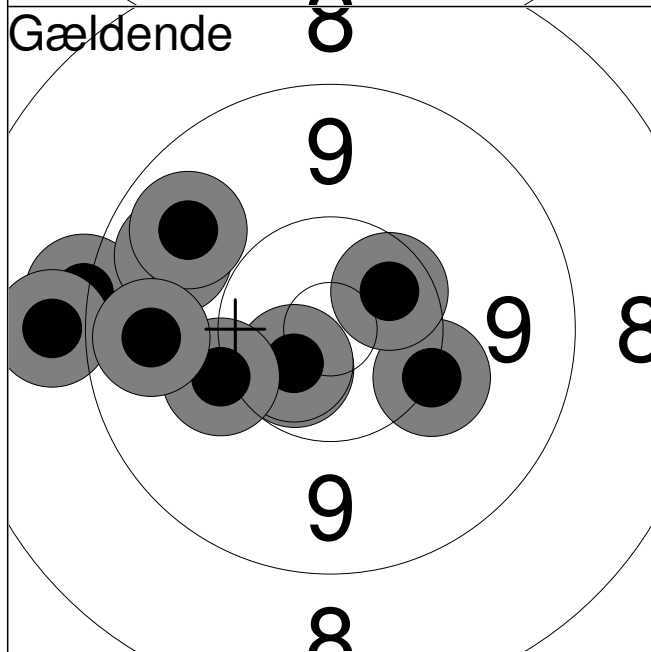

| | | |
|-----|-------|---|
| 11: | 9.1 | ↖ |
| 12: | 8.9 | ↖ |
| 13: | 9.7 | ↗ |
| 14: | 9.7 | ↗ |
| 15: | 10.2 | ↘ |
| 16: | *10.6 | ↘ |
| 17: | *10.6 | ↘ |
| 18: | 10.1 | ↖ |
| 19: | *10.5 | ↗ |
| 20: | 9.7 | ↖ |

| | |
|-------|-------|
| Serie | 94.0 |
| Total | 194.0 |

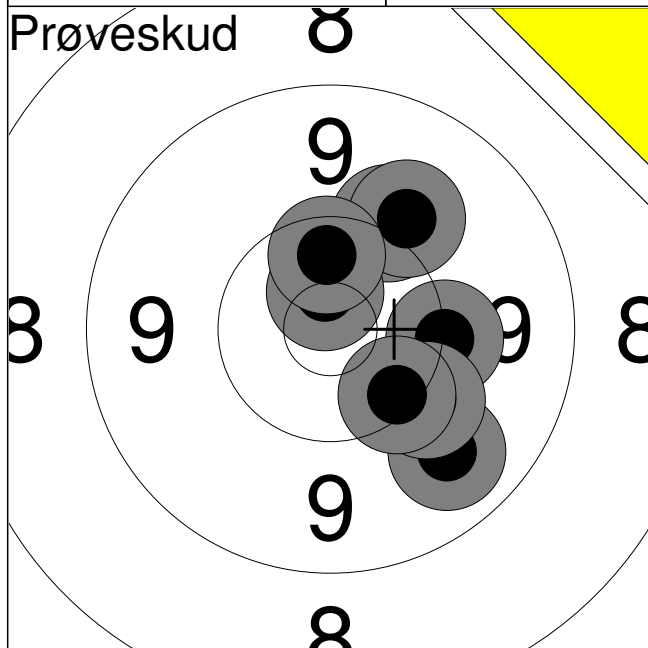

| | | |
|----|-------|---|
| 1: | 10.1 | ↗ |
| 2: | 10.1 | → |
| 3: | 9.8 | ↘ |
| 4: | *10.7 | ↗ |
| 5: | 10.1 | ↘ |
| 6: | 10.0 | ↗ |
| 7: | 10.3 | ↘ |
| 8: | *10.4 | ↗ |

| | |
|-------|------|
| Serie | 79.0 |
|-------|------|

| | |
|-------|-----|
| Total | 0.0 |
|-------|-----|

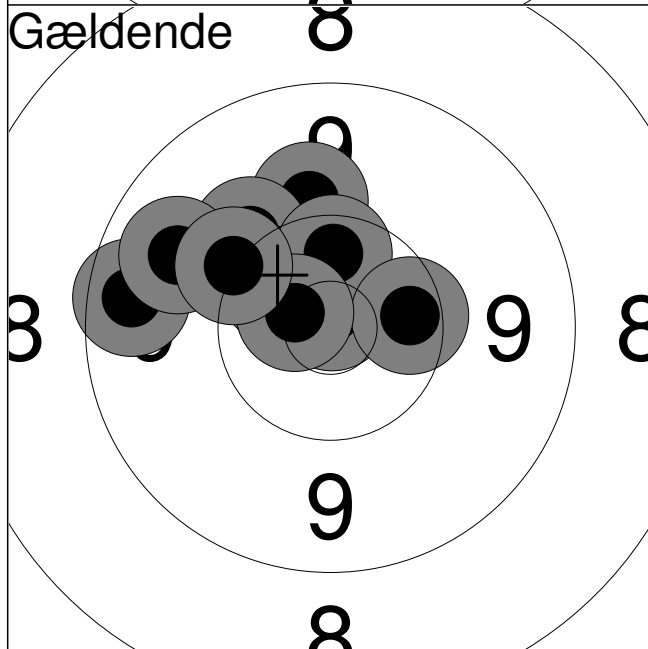

| | | |
|-----|-------|---|
| 1: | 10.0 | ↗ |
| 2: | 10.1 | ↗ |
| 3: | *10.8 | ↗ |
| 4: | *10.5 | ↗ |
| 5: | *10.4 | ↗ |
| 6: | 9.5 | ← |
| 7: | 9.7 | ↗ |
| 8: | 10.4 | → |
| 9: | *10.7 | ↗ |
| 10: | 10.1 | ↗ |

| | |
|-------|------|
| Serie | 98.0 |
|-------|------|

| | |
|-------|------|
| Total | 98.0 |
|-------|------|

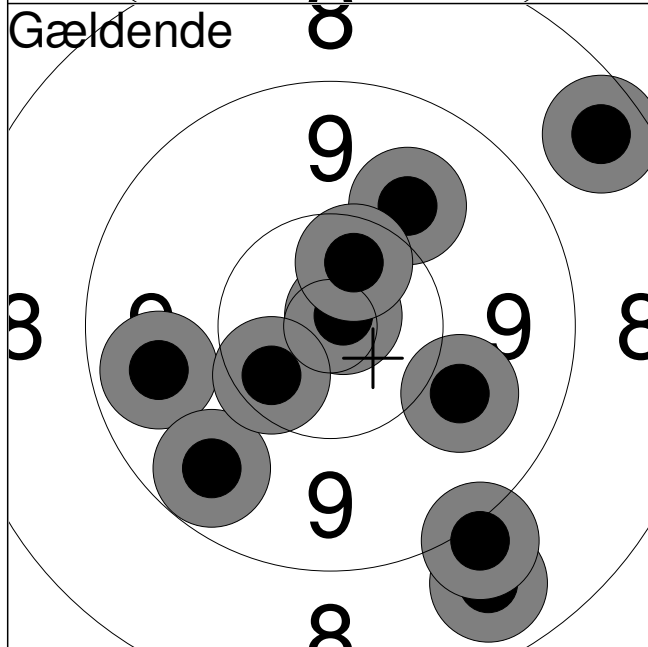

| | | |
|-----|-------|---|
| 11: | *10.8 | ↗ |
| 12: | 8.7 | ↘ |
| 13: | 8.5 | ↗ |
| 14: | 9.7 | ← |
| 15: | 9.0 | ↘ |
| 16: | 9.9 | ↘ |
| 17: | 9.9 | ↗ |
| 18: | *10.5 | ↗ |
| 19: | 9.6 | ↘ |
| 20: | 10.4 | ↙ |

| | |
|-------|------|
| Serie | 91.0 |
|-------|------|

| | |
|-------|-------|
| Total | 189.0 |
|-------|-------|



| | | |
|-----|-------|---|
| 1: | 10.4 | ↘ |
| 2: | 10.0 | ↗ |
| 3: | *10.7 | ↘ |
| 4: | 10.1 | ↗ |
| 5: | 10.3 | ↗ |
| 6: | *10.5 | ↗ |
| 7: | 9.4 | → |
| 8: | 9.8 | ↗ |
| 9: | 9.7 | → |
| 10: | *10.9 | ↗ |

| | |
|-------|------|
| Serie | 97.0 |
| Total | 0.0 |

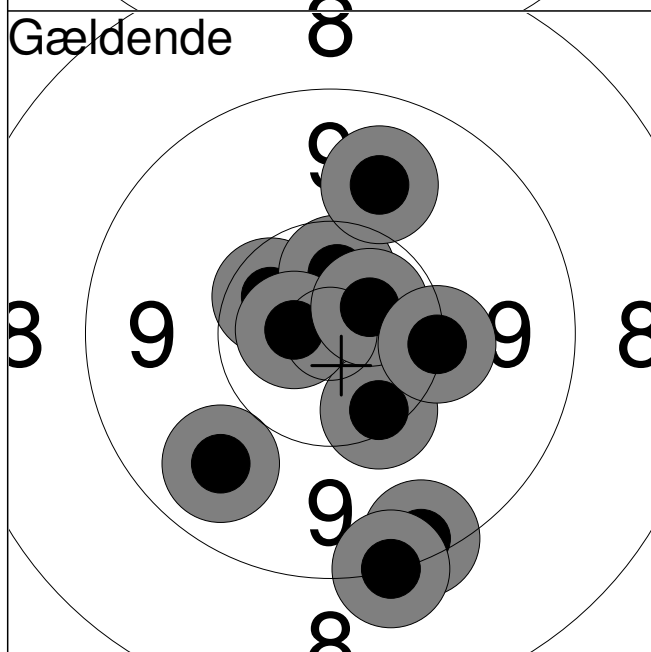

| | | |
|-----|-------|---|
| 1: | 10.3 | ↘ |
| 2: | *10.5 | ↗ |
| 3: | 9.7 | ↘ |
| 4: | *10.5 | ↗ |
| 5: | *10.7 | ← |
| 6: | 9.3 | ↘ |
| 7: | 9.8 | ↗ |
| 8: | *10.6 | ↗ |
| 9: | 10.2 | → |
| 10: | 9.2 | ↘ |

| | |
|-------|------|
| Serie | 96.0 |
| Total | 96.0 |

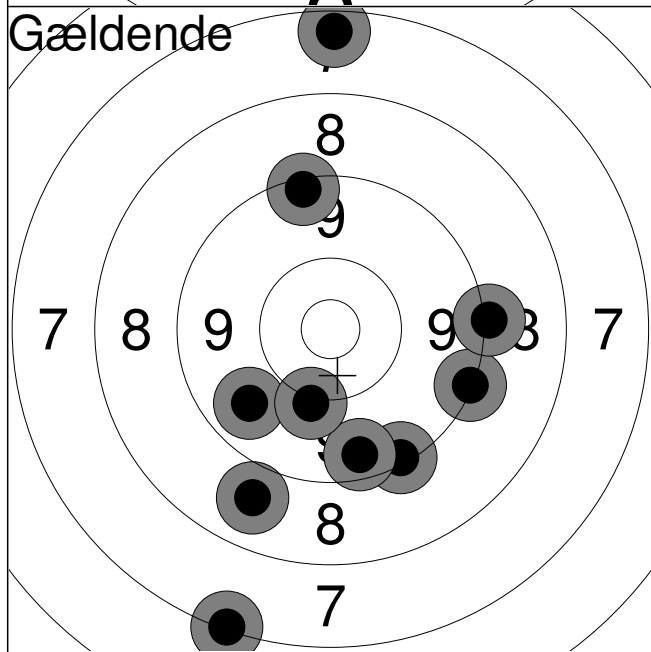

| | | |
|-----|------|---|
| 11: | 7.4 | ↑ |
| 12: | 9.7 | ↙ |
| 13: | 9.3 | ↗ |
| 14: | 7.2 | ↘ |
| 15: | 8.8 | ↘ |
| 16: | 9.3 | ↘ |
| 17: | 9.2 | → |
| 18: | 9.5 | ↘ |
| 19: | 9.1 | → |
| 20: | 10.1 | ↘ |

| | |
|-------|-------|
| Serie | 86.0 |
| Total | 182.0 |

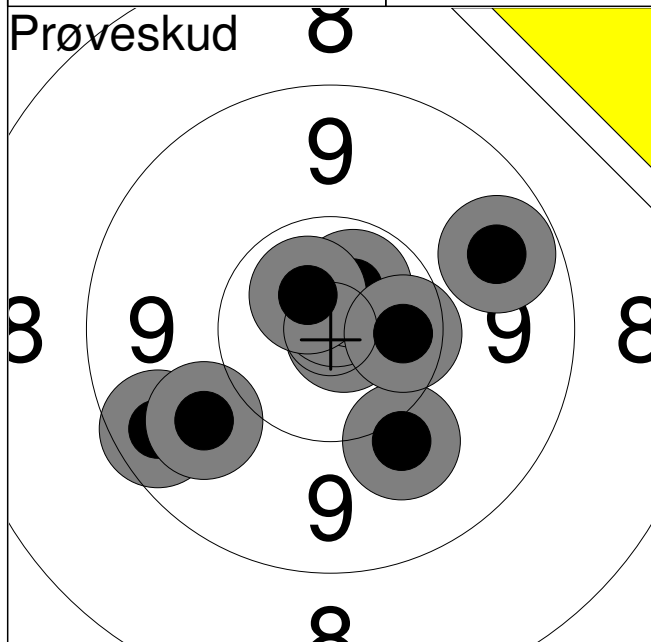

| | | |
|--------------|-------|-------------|
| 1: | 10.0 | ↘ |
| 2: | 9.5 | ↙ |
| 3: | 9.8 | ↙ |
| 4: | *10.8 | → |
| 5: | 9.6 | → |
| 6: | *10.8 | ↑ |
| 7: | *10.6 | ↗ |
| 8: | *10.7 | ↗ |
| 9: | *10.4 | → |
| Serie | | 87.0 |
| Total | | 0.0 |

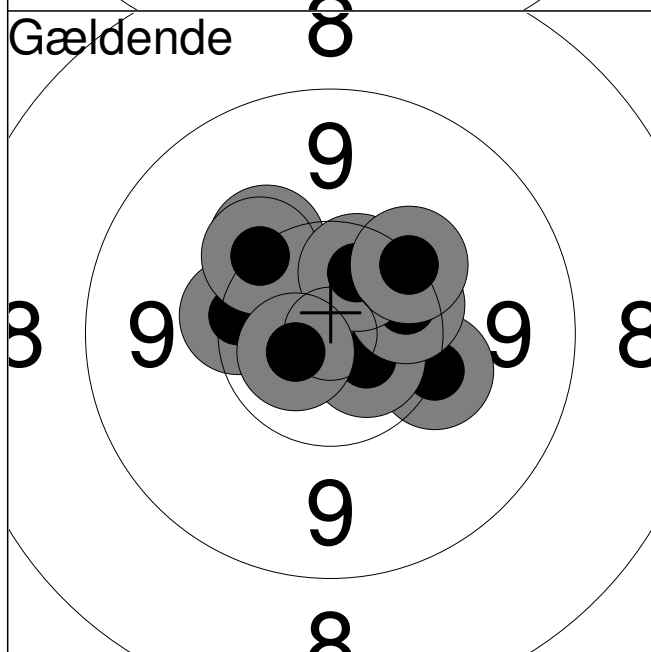

| | | |
|--------------|-------|--------------|
| 1: | 10.2 | → |
| 2: | 10.3 | ← |
| 3: | *10.7 | ↗ |
| 4: | 10.2 | ↗ |
| 5: | *10.6 | ↘ |
| 6: | 10.4 | → |
| 7: | 10.2 | ↗ |
| 8: | *10.5 | ↗ |
| 9: | *10.7 | ↙ |
| 10: | 10.2 | ↗ |
| Serie | | 100.0 |
| Total | | 100.0 |

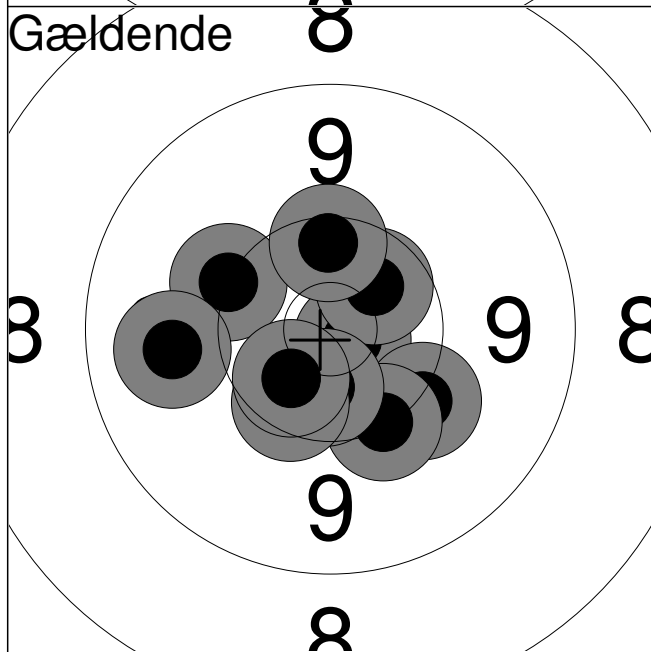

| | | |
|--------------|-------|--------------|
| 11: | *10.8 | → |
| 12: | 10.2 | ↗ |
| 13: | *10.5 | ↗ |
| 14: | 10.1 | ↘ |
| 15: | 10.2 | ↘ |
| 16: | *10.5 | ↘ |
| 17: | 9.8 | ← |
| 18: | 10.4 | ↙ |
| 19: | *10.5 | ↙ |
| 20: | 10.3 | ↑ |
| Serie | | 99.0 |
| Total | | 199.0 |

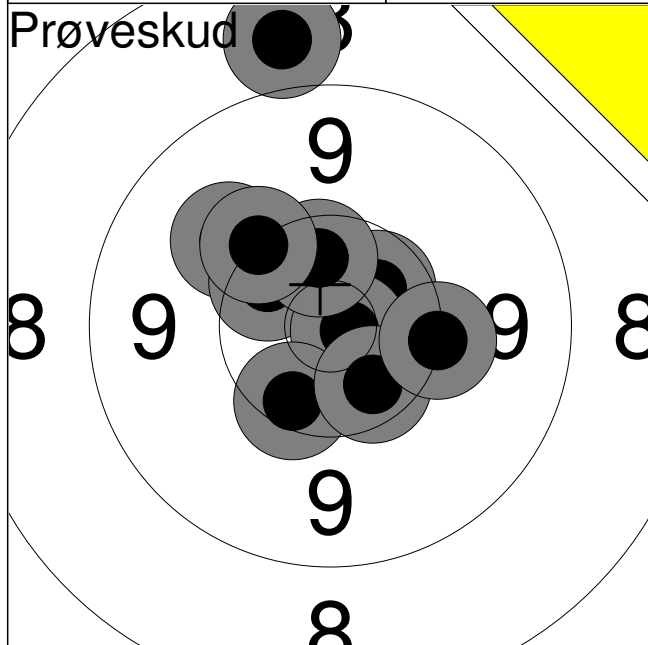

| | | |
|-----|-------|---|
| 1: | 8.8 | ↑ |
| 2: | 10.0 | ↗ |
| 3: | *10.5 | → |
| 4: | 10.4 | ↗ |
| 5: | *10.8 | ↘ |
| 6: | *10.5 | ↗ |
| 7: | 10.4 | ↘ |
| 8: | 10.2 | ↗ |
| 9: | *10.4 | ↘ |
| 10: | 10.2 | → |

| | |
|-------|------|
| Serie | 98.0 |
|-------|------|

| | |
|-------|-----|
| Total | 0.0 |
|-------|-----|

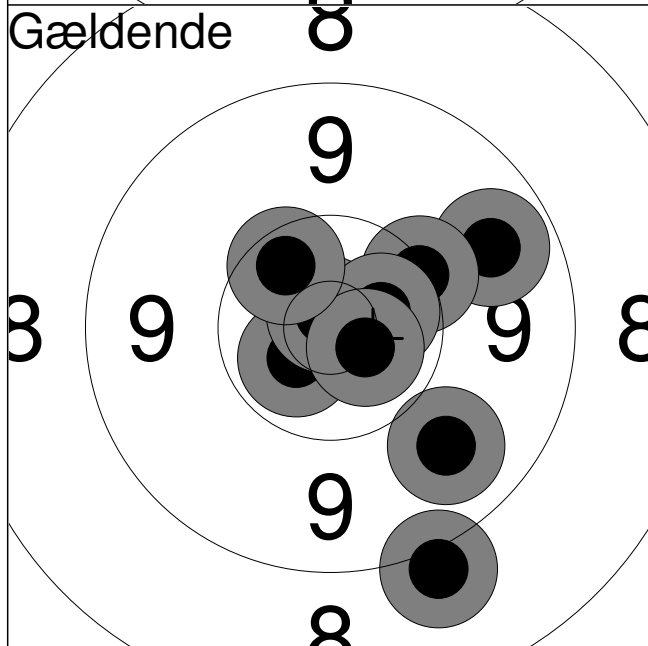

| | | |
|-----|-------|---|
| 1: | 9.0 | ↘ |
| 2: | *10.8 | ↖ |
| 3: | 9.7 | → |
| 4: | *10.6 | ↖ |
| 5: | 10.2 | ↗ |
| 6: | *10.8 | ↗ |
| 7: | *10.6 | → |
| 8: | *10.7 | ↘ |
| 9: | 9.8 | ↘ |
| 10: | 10.4 | ↗ |

| | |
|-------|------|
| Serie | 97.0 |
|-------|------|

| | |
|-------|------|
| Total | 97.0 |
|-------|------|

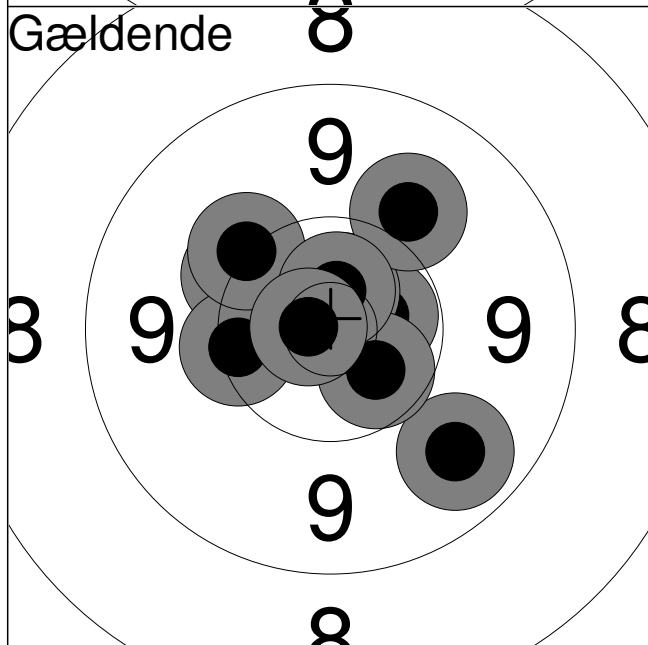

| | | |
|-----|-------|---|
| 11: | *10.6 | → |
| 12: | 10.2 | ↗ |
| 13: | *10.7 | ↑ |
| 14: | 9.7 | ↘ |
| 15: | *10.5 | ↘ |
| 16: | 10.0 | ↗ |
| 17: | 10.3 | ← |
| 18: | 10.1 | ↗ |
| 19: | *10.7 | ↑ |
| 20: | *10.8 | ← |

| | |
|-------|------|
| Serie | 99.0 |
|-------|------|

| | |
|-------|-------|
| Total | 196.0 |
|-------|-------|

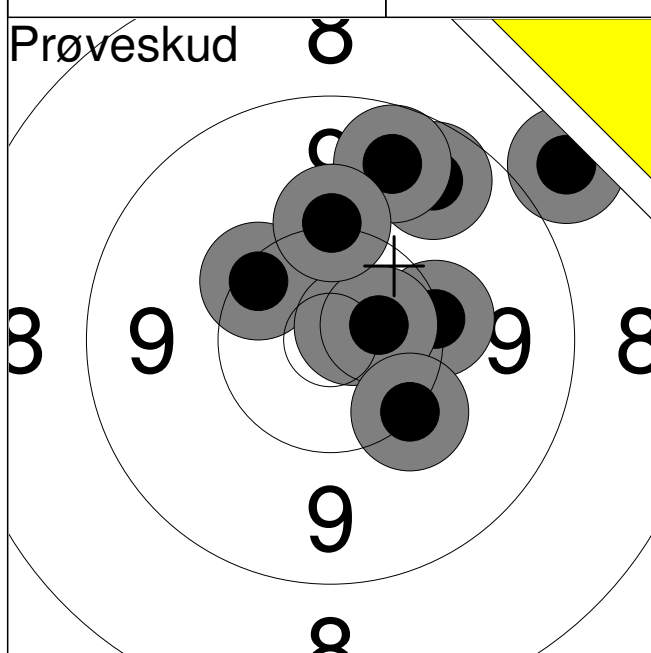

| | | |
|----|-------|---|
| 1: | 8.8 | ↗ |
| 2: | 9.6 | ↗ |
| 3: | 9.6 | ↗ |
| 4: | 10.3 | ↗ |
| 5: | *10.8 | ↗ |
| 6: | 10.2 | → |
| 7: | *10.6 | → |
| 8: | 10.2 | ↘ |
| 9: | 10.1 | ↑ |

| | |
|-------|------|
| Serie | 86.0 |
| Total | 0.0 |

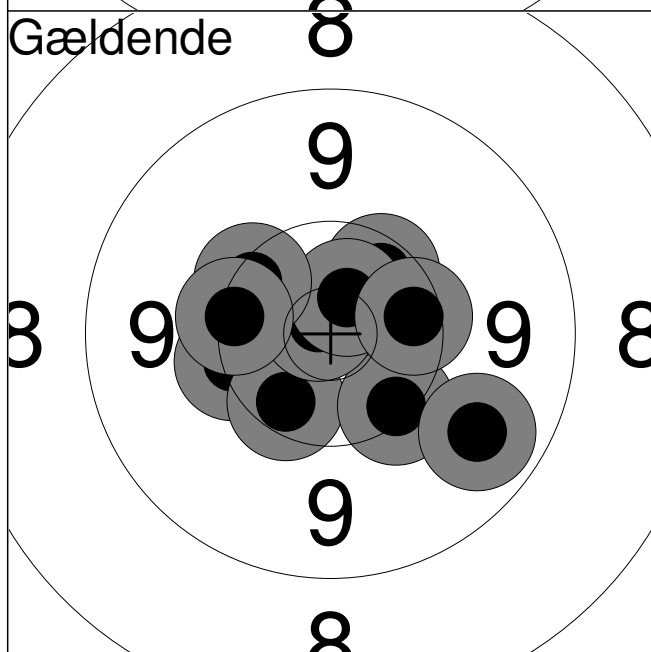

| | | |
|-----|-------|---|
| 1: | 10.2 | ← |
| 2: | 10.4 | ↙ |
| 3: | 10.3 | ↘ |
| 4: | 9.7 | ↘ |
| 5: | 10.4 | ↗ |
| 6: | *10.8 | ↗ |
| 7: | *10.7 | ↗ |
| 8: | 10.3 | ↗ |
| 9: | 10.4 | → |
| 10: | 10.3 | ← |

| | |
|-------|------|
| Serie | 99.0 |
| Total | 99.0 |

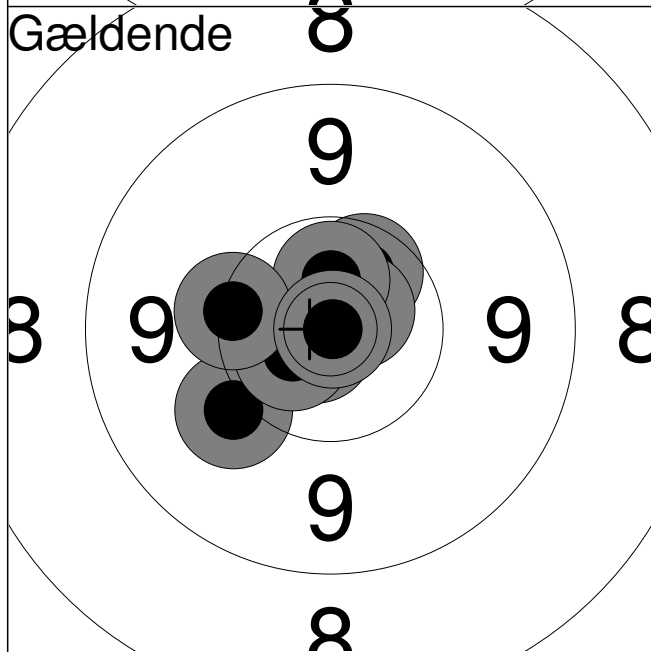

| | | |
|-----|-------|---|
| 11: | *10.5 | ↗ |
| 12: | *10.8 | ↙ |
| 13: | *10.4 | ← |
| 14: | *10.7 | ↗ |
| 15: | *10.7 | ↙ |
| 16: | 10.1 | ↙ |
| 17: | *10.6 | ↑ |
| 18: | *10.6 | ↙ |
| 19: | 10.3 | ← |
| 20: | *10.9 | → |

| | |
|-------|-------|
| Serie | 100.0 |
| Total | 199.0 |

| | | | |
|------|-------|-----------------|--|
| Hold | Skive | Nicki Fabricius | |
|------|-------|-----------------|--|

| | | |
|-----|-----------------------|---|
| 50m | Sparta Idrætsforening | 2 |
|-----|-----------------------|---|

| | | |
|---------------|------------------|---------------------|
| 29/5-2/6 2013 | Jeppestævne 2013 | Aalborg Skyttekreds |
|---------------|------------------|---------------------|

| | |
|---------------------------------|-------------------------------|
| Ant. obligatoriske træningsskud | Arrangørlaget navn og stempel |
|---------------------------------|-------------------------------|

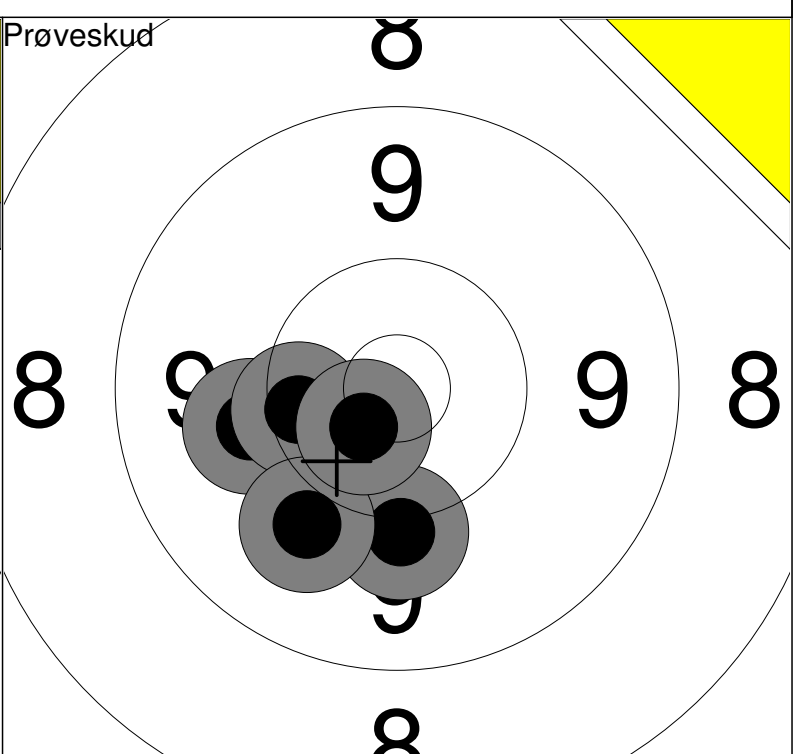
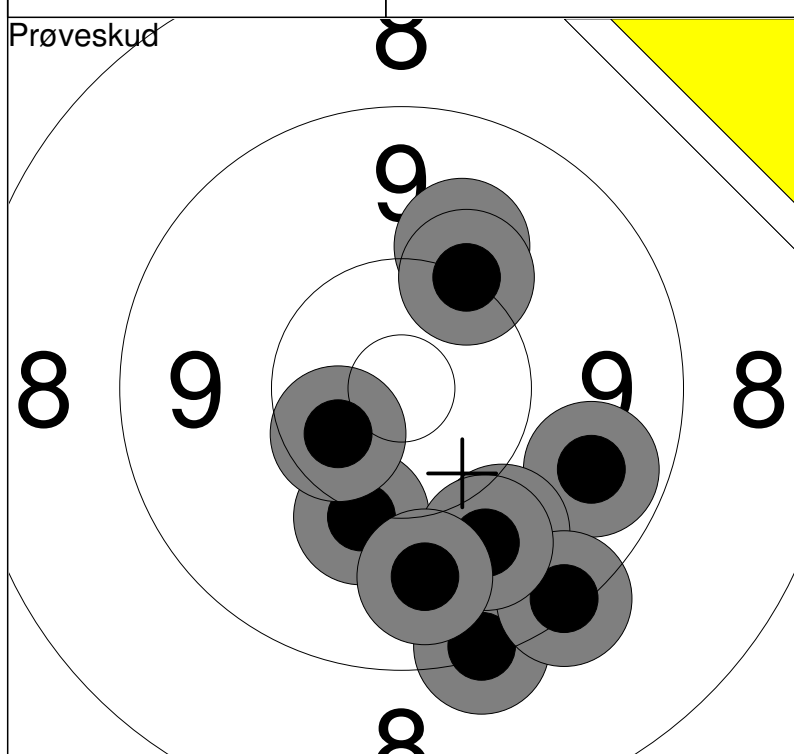

| | | | |
|-----------|------------|-------|----|
| 1: 10.0 ↗ | 6: 9.3 ↓ | Serie | 94 |
| 2: 10.2 ↗ | 7: 10.1 ↓ | | |
| 3: 9.2 ↓ | 8: *10.5 ← | Total | 0 |
| 4: 9.7 ↘ | 9: 9.9 ↓ | | |
| 5: 9.9 ↓ | 10: 9.8 ↓ | | |

| | | |
|-------------|-------|----|
| 11: 10.1 ↓ | Serie | 50 |
| 12: 10.0 ← | | |
| 13: 10.3 ← | Total | 0 |
| 14: 10.0 ↓ | | |
| 15: *10.6 ↘ | | |

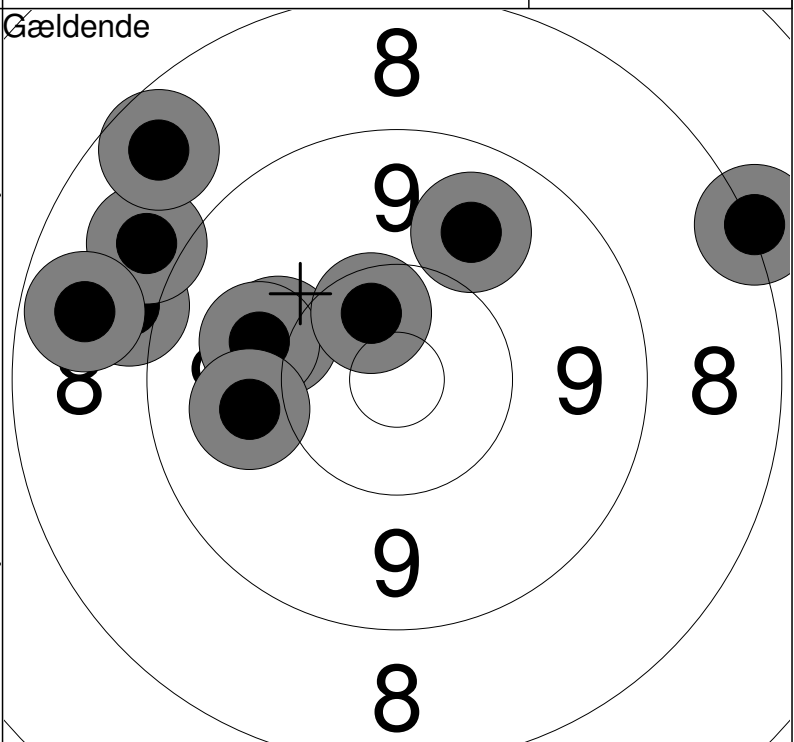
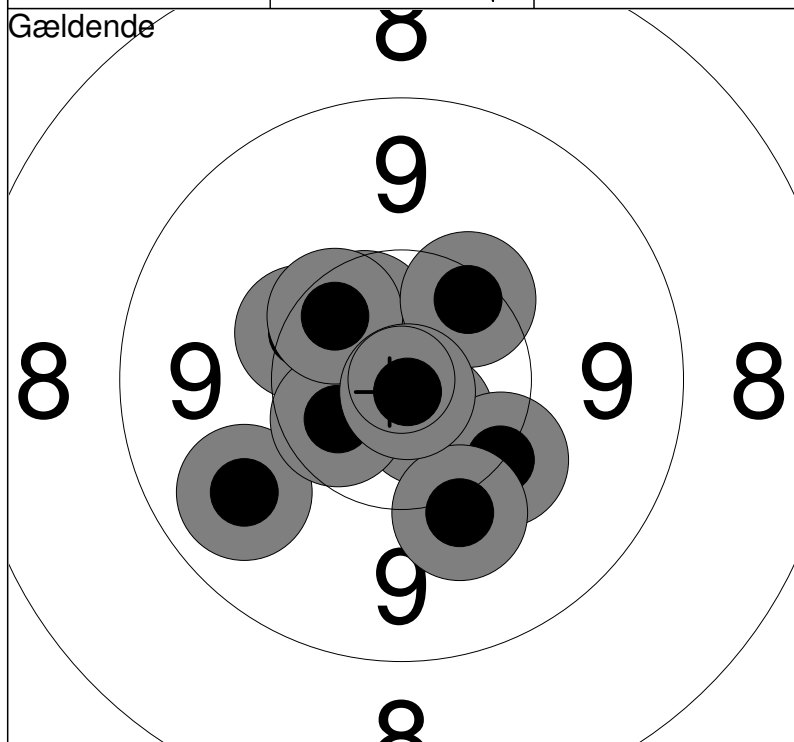

| | | | |
|------------|-------------|-------|----|
| 1: 9.8 ↙ | 6: *10.5 ← | Serie | 99 |
| 2: *10.5 ↗ | 7: 10.1 ↓ | | |
| 3: *10.7 ↓ | 8: 10.4 ↗ | Total | 99 |
| 4: 10.3 ↗ | 9: 10.3 ↗ | | |
| 5: 10.2 ↓ | 10: *10.9 ↓ | | |

| | | | |
|------------|-------------|-------|-----|
| 11: 9.0 ← | 16: 9.8 ↗ | Serie | 89 |
| 12: 8.9 ↗ | 17: 10.0 ← | | |
| 13: 8.1 ↗ | 18: 8.7 ← | Total | 188 |
| 14: 8.6 ↗ | 19: 9.9 ← | | |
| 15: 10.1 ← | 20: *10.5 ↗ | | |

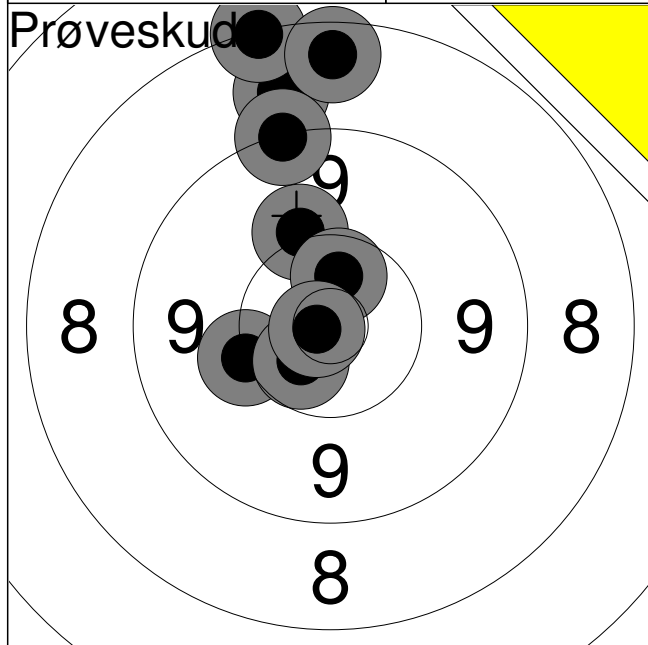

| | | |
|----|-------|---|
| 1: | 8.8 | ↑ |
| 2: | 8.2 | ↑ |
| 3: | 8.5 | ↑ |
| 4: | 10.2 | ← |
| 5: | *10.6 | ↙ |
| 6: | 10.1 | ↑ |
| 7: | 9.2 | ↑ |
| 8: | *10.5 | ↑ |
| 9: | *10.8 | ← |

| | |
|-------|------|
| Serie | 83.0 |
|-------|------|

| | |
|-------|-----|
| Total | 0.0 |
|-------|-----|

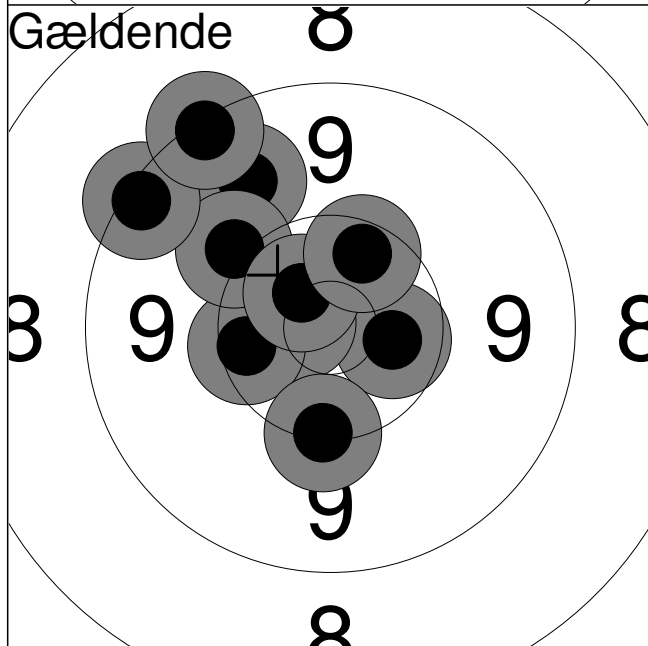

| | | |
|-----|-------|---|
| 1: | 9.8 | ↗ |
| 2: | *10.5 | → |
| 3: | *10.7 | ← |
| 4: | 10.3 | ← |
| 5: | 10.1 | ↗ |
| 6: | 9.3 | ↗ |
| 7: | 10.2 | ↓ |
| 8: | *10.6 | ↗ |
| 9: | 9.3 | ↗ |
| 10: | 10.4 | ↑ |

| | |
|-------|------|
| Serie | 97.0 |
|-------|------|

| | |
|-------|------|
| Total | 97.0 |
|-------|------|

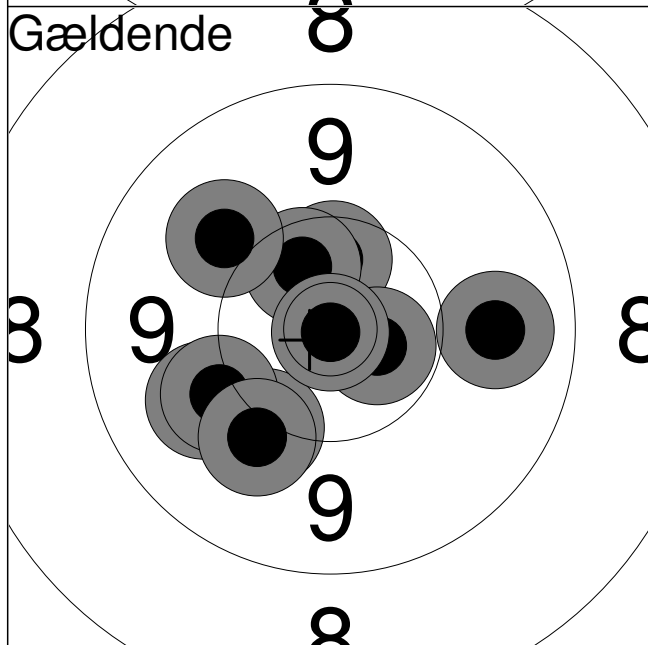

| | | |
|-----|-------|---|
| 11: | *10.5 | ↑ |
| 12: | *10.6 | → |
| 13: | 9.9 | ← |
| 14: | 10.1 | ↙ |
| 15: | *10.5 | ↑ |
| 16: | *10.9 | ↓ |
| 17: | 10.0 | ← |
| 18: | 9.8 | → |
| 19: | 10.0 | ↗ |
| 20: | 10.0 | ↙ |

| | |
|-------|------|
| Serie | 98.0 |
|-------|------|

| | |
|-------|-------|
| Total | 195.0 |
|-------|-------|

| | | | |
|------|-------|----------|--|
| Hold | Skive | Kaj Mørk | |
| 16 | 9 | | |

| | | |
|-----|---------------------|----|
| 50m | Vester Hassing Skf. | J1 |
|-----|---------------------|----|

| | | |
|---------------|------------------|---------------------|
| 29/5-2/6 2013 | Jeppestævne 2013 | Aalborg Skyttekreds |
|---------------|------------------|---------------------|

| | |
|--------------------------------|--------------------------------|
| Ant. obligatoriske træningskud | Arrangørlagets navn og stempel |
|--------------------------------|--------------------------------|

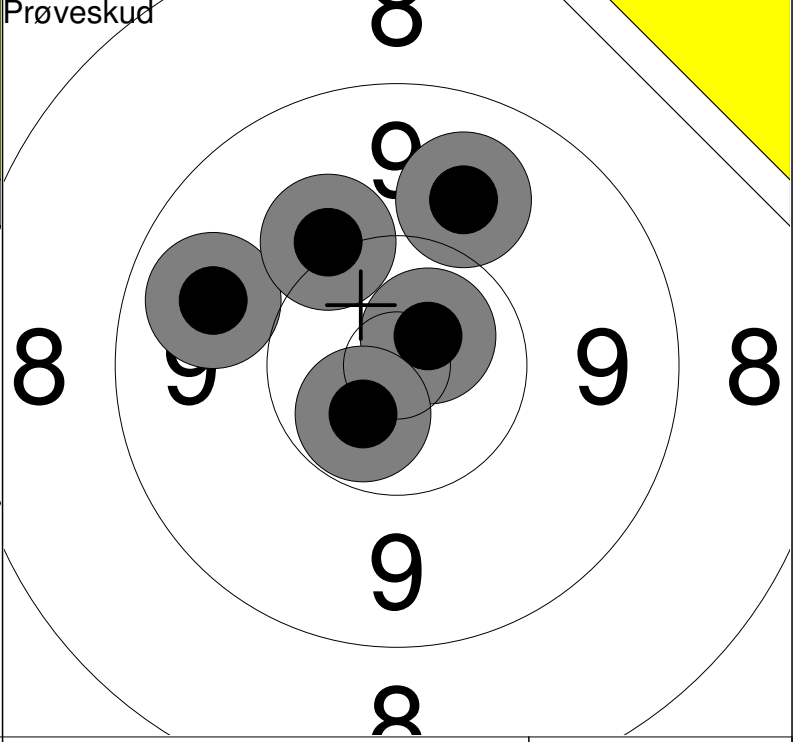
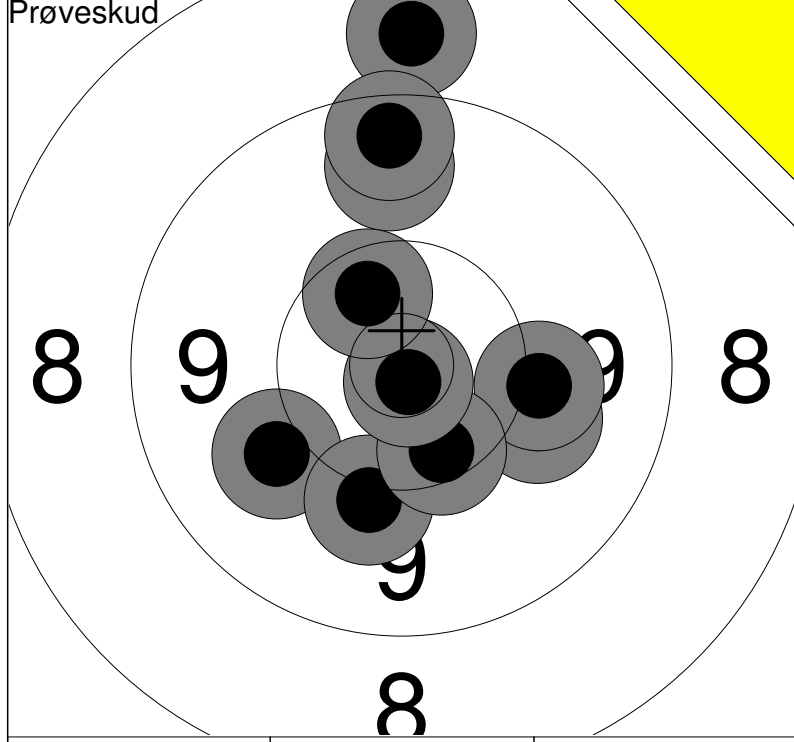

| | | | |
|-----------|------------|-------|----|
| 1: 10.0 → | 6: 9.7 ↑ | Serie | 96 |
| 2: 10.1 → | 7: 8.8 ↑ | | |
| 3: 10.0 ↙ | 8: *10.8 ↓ | Total | 0 |
| 4: 10.1 ↓ | 9: *10.4 ↑ | | |
| 5: 10.4 ↓ | 10: 9.5 ↑ | | |

| | | |
|-------------|-------|----|
| 11: 9.7 ← | Serie | 48 |
| 12: *10.7 ↗ | | |
| 13: 10.1 ↖ | Total | 0 |
| 14: 9.9 ↑ | | |
| 15: *10.6 ↘ | | |

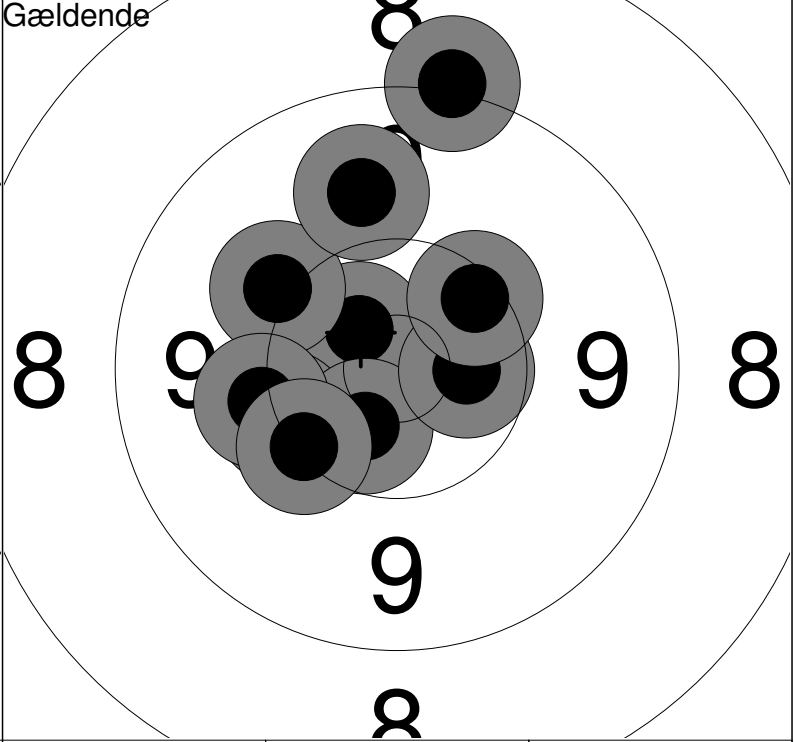
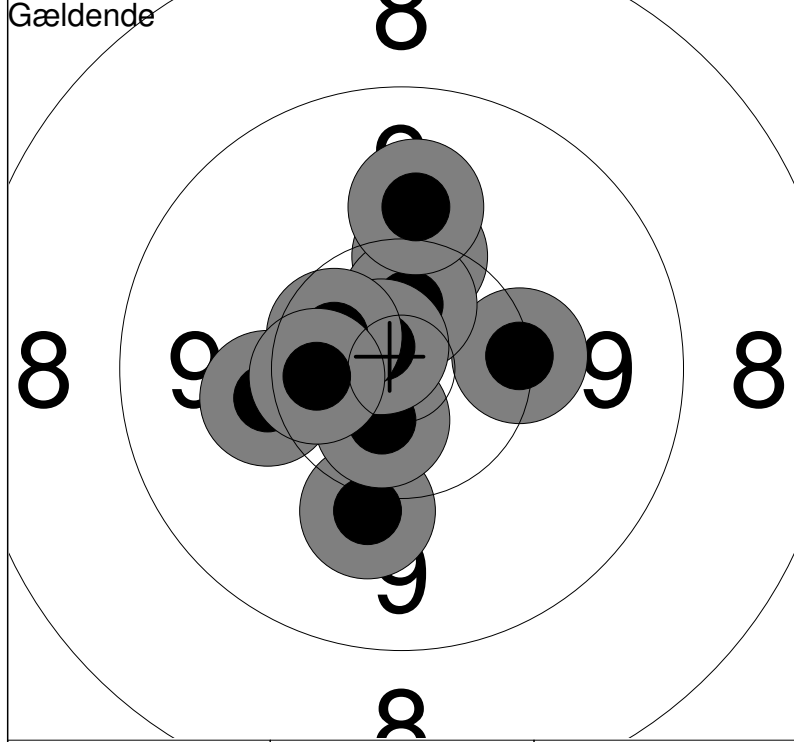

| | | | |
|------------|-------------|-------|-----|
| 1: 10.1 ↓ | 6: *10.6 ↑ | Serie | 100 |
| 2: 10.2 → | 7: 10.0 ↑ | | |
| 3: 10.3 ↑ | 8: *10.8 ↖ | Total | 100 |
| 4: *10.6 ↓ | 9: *10.5 ↖ | | |
| 5: 10.1 ← | 10: *10.4 ← | | |

| | | | |
|-------------|-------------|-------|-----|
| 11: *10.6 ↖ | 16: *10.5 → | Serie | 98 |
| 12: 10.2 ← | 17: 9.8 ↑ | | |
| 13: *10.5 ↓ | 18: 10.3 ↗ | Total | 198 |
| 14: 10.1 ↖ | 19: 10.1 ← | | |
| 15: 9.1 ↑ | 20: 10.2 ↘ | | |

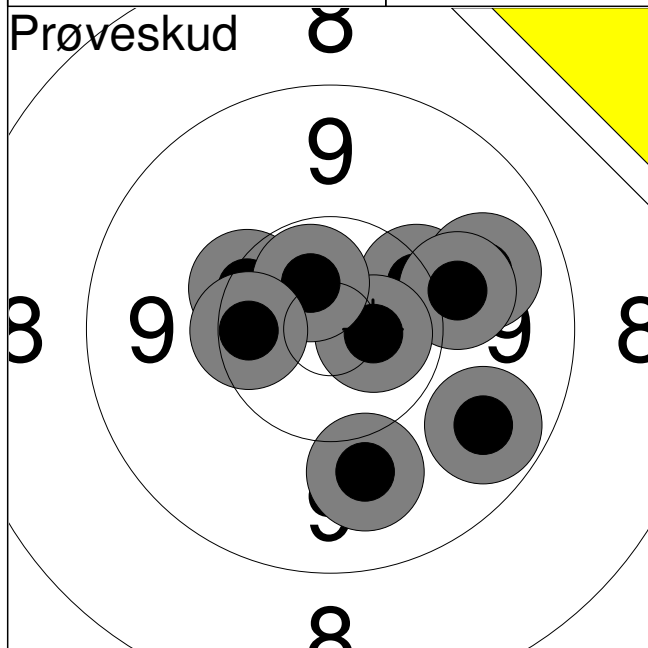

| | | |
|----|-------|---|
| 1: | 10.3 | ↗ |
| 2: | 9.8 | → |
| 3: | 9.7 | ↘ |
| 4: | 10.0 | → |
| 5: | *10.6 | → |
| 6: | 10.3 | ↗ |
| 7: | *10.6 | ↗ |
| 8: | 9.9 | ↘ |
| 9: | 10.4 | ← |

| | |
|-------|------|
| Serie | 87.0 |
|-------|------|

| | |
|-------|-----|
| Total | 0.0 |
|-------|-----|

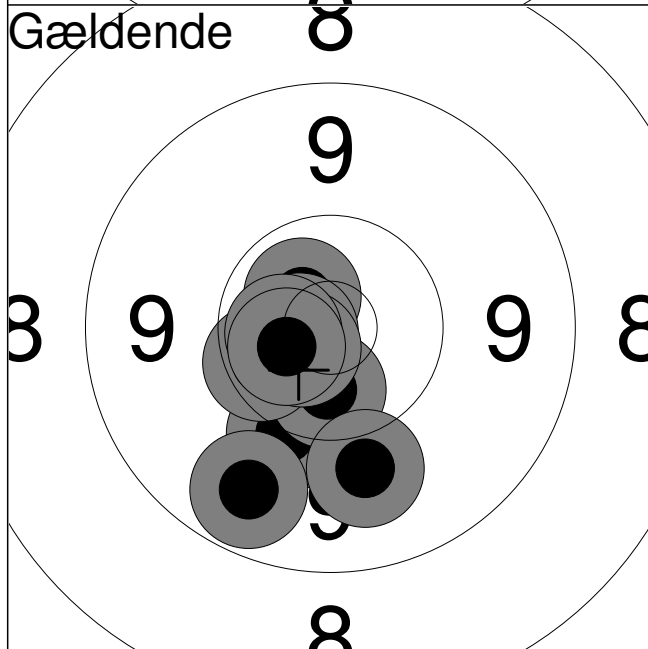

| | | |
|-----|-------|---|
| 1: | 10.1 | ↘ |
| 2: | 9.7 | ↘ |
| 3: | *10.7 | ↗ |
| 4: | *10.5 | ↘ |
| 5: | 10.4 | ← |
| 6: | *10.7 | ← |
| 7: | *10.7 | ← |
| 8: | *10.6 | ← |
| 9: | 9.9 | ↘ |
| 10: | *10.6 | ← |

| | |
|-------|------|
| Serie | 98.0 |
|-------|------|

| | |
|-------|------|
| Total | 98.0 |
|-------|------|

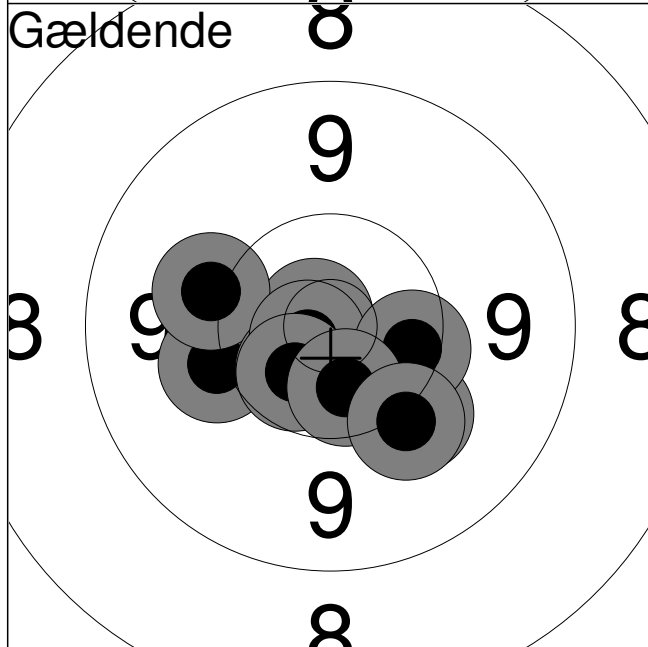

| | | |
|-----|-------|---|
| 11: | *10.8 | ↗ |
| 12: | 10.1 | ← |
| 13: | 10.1 | ↗ |
| 14: | 10.1 | ↘ |
| 15: | *10.6 | ← |
| 16: | *10.8 | ← |
| 17: | *10.5 | ↘ |
| 18: | 10.4 | → |
| 19: | *10.5 | ↘ |
| 20: | 10.1 | ↘ |

| | |
|-------|-------|
| Serie | 100.0 |
|-------|-------|

| | |
|-------|-------|
| Total | 198.0 |
|-------|-------|

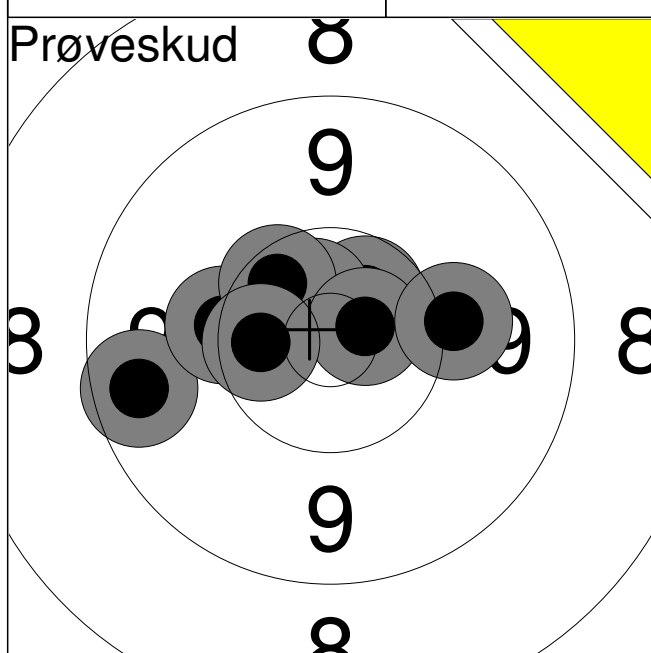

| | | |
|----|-------|---|
| 1: | 9.5 | ← |
| 2: | *10.5 | ↗ |
| 3: | *10.6 | ↗ |
| 4: | 10.2 | ← |
| 5: | 10.4 | ↗ |
| 6: | *10.7 | → |
| 7: | 10.1 | → |
| 8: | *10.5 | ← |

| | |
|-------|------|
| Serie | 79.0 |
| Total | 0.0 |

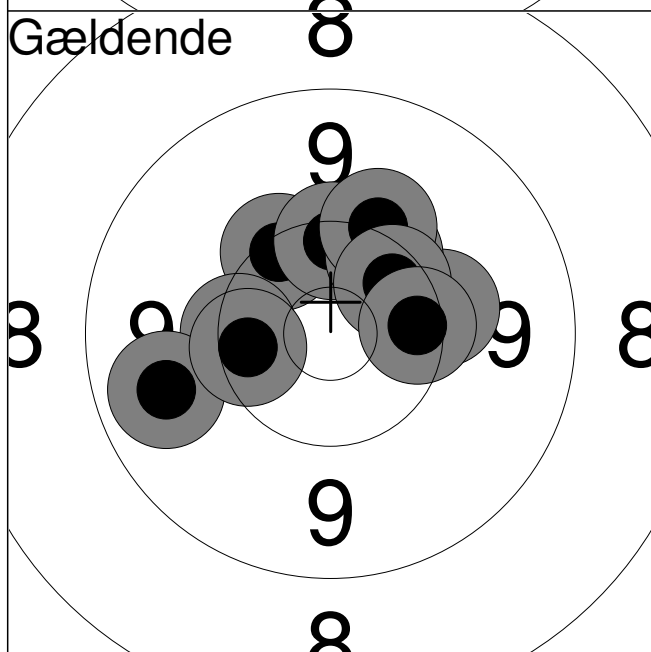

| | | |
|-----|------|---|
| 1: | 10.3 | ↗ |
| 2: | 10.3 | ← |
| 3: | 9.7 | ← |
| 4: | 10.2 | → |
| 5: | 10.4 | ← |
| 6: | 10.3 | ↑ |
| 7: | 10.3 | ↗ |
| 8: | 10.1 | ↗ |
| 9: | 10.4 | ↗ |
| 10: | 10.3 | → |

| | |
|-------|------|
| Serie | 99.0 |
| Total | 99.0 |

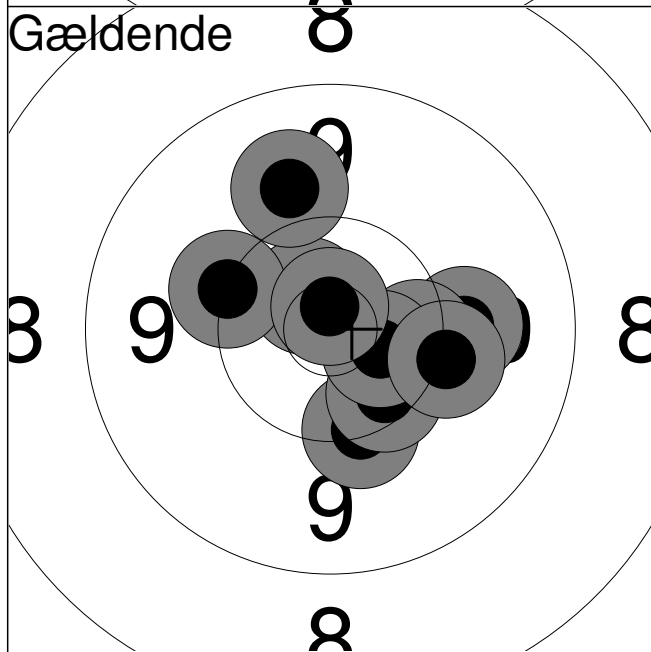

| | | |
|-----|-------|---|
| 11: | 10.0 | → |
| 12: | 10.2 | ↓ |
| 13: | *10.7 | ↗ |
| 14: | 10.4 | ↓ |
| 15: | 10.3 | → |
| 16: | *10.6 | ↓ |
| 17: | 10.1 | ↓ |
| 18: | 10.2 | ↗ |
| 19: | 9.9 | ↗ |
| 20: | *10.8 | ↑ |

| | |
|-------|-------|
| Serie | 99.0 |
| Total | 198.0 |

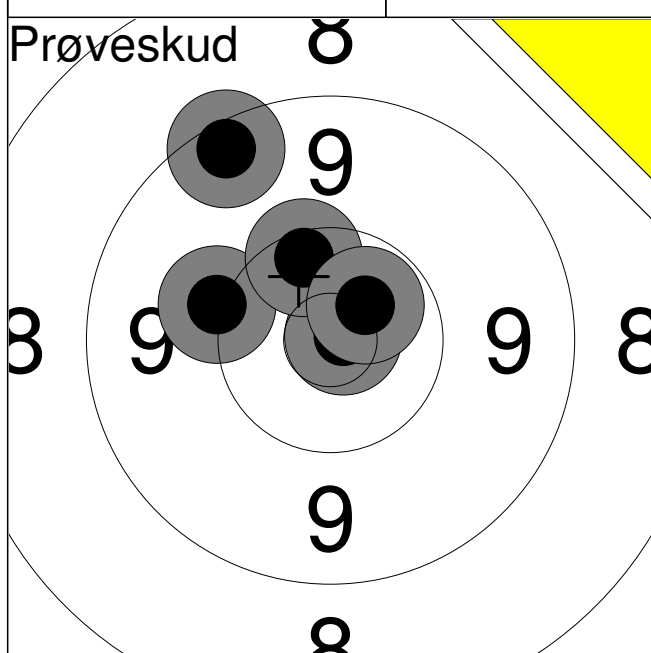

| | | |
|----|-------|---|
| 1: | 9.4 | ↗ |
| 2: | *10.9 | → |
| 3: | 10.1 | ↖ |
| 4: | 10.3 | ↗ |
| 5: | *10.6 | ↗ |

| | |
|-------|------|
| Serie | 49.0 |
| Total | 0.0 |

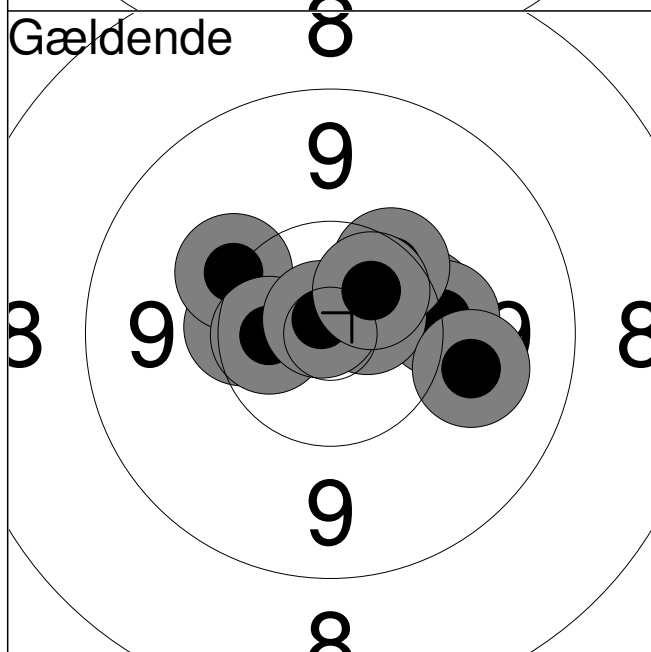

| | | |
|-----|-------|---|
| 1: | 10.3 | → |
| 2: | 10.3 | ← |
| 3: | 10.1 | ↗ |
| 4: | 10.2 | → |
| 5: | *10.5 | ← |
| 6: | *10.7 | → |
| 7: | 9.9 | → |
| 8: | *10.8 | ↗ |
| 9: | 10.3 | ↗ |
| 10: | *10.5 | ↗ |

| | |
|-------|------|
| Serie | 99.0 |
| Total | 99.0 |

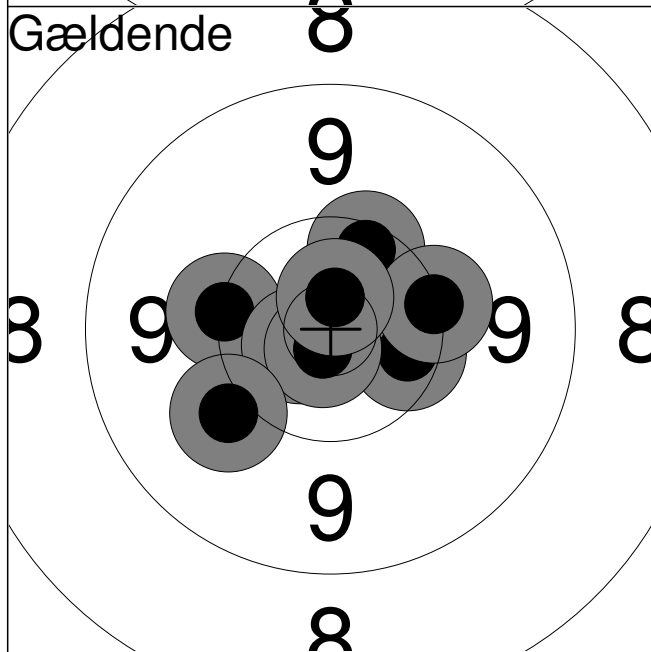

| | | |
|-----|-------|---|
| 11: | *10.8 | ↗ |
| 12: | *10.6 | → |
| 13: | 10.3 | ↗ |
| 14: | 10.2 | ← |
| 15: | *10.7 | ← |
| 16: | 10.4 | → |
| 17: | *10.8 | ↓ |
| 18: | 10.0 | ← |
| 19: | 10.2 | → |
| 20: | *10.7 | ↑ |

| | |
|-------|-------|
| Serie | 100.0 |
| Total | 199.0 |

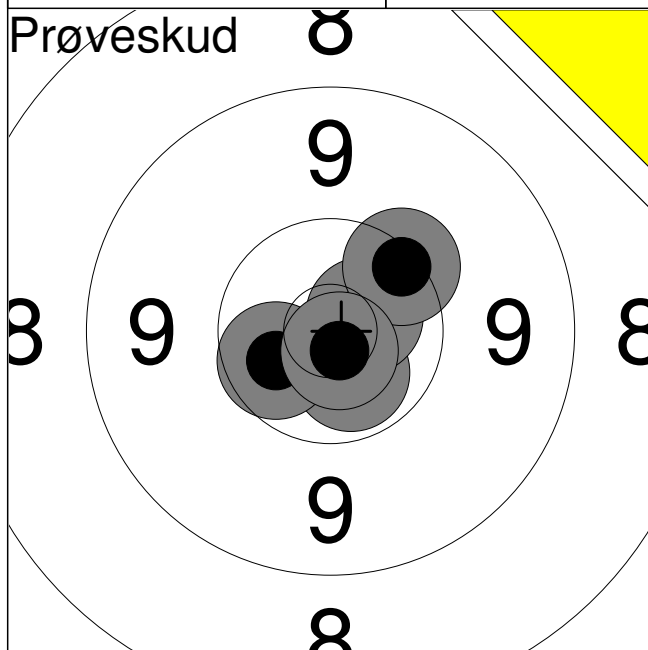

| | | |
|----|-------|---|
| 1: | *10.6 | ↓ |
| 2: | *10.5 | ↙ |
| 3: | *10.7 | → |
| 4: | 10.3 | ↗ |
| 5: | *10.8 | ↓ |

| | |
|-------|------|
| Serie | 50.0 |
| Total | 0.0 |

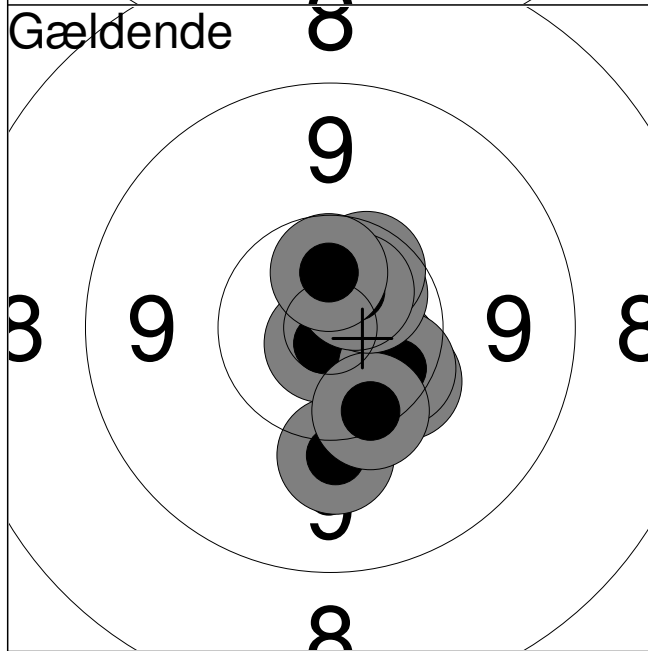

| | | |
|-----|-------|---|
| 1: | *10.5 | ↘ |
| 2: | *10.8 | ↓ |
| 3: | 10.3 | ↘ |
| 4: | 10.4 | ↘ |
| 5: | 10.1 | ↓ |
| 6: | 10.3 | ↓ |
| 7: | *10.6 | ↗ |
| 8: | *10.5 | ↗ |
| 9: | *10.6 | ↗ |
| 10: | *10.6 | ↑ |

| | |
|-------|-------|
| Serie | 100.0 |
| Total | 100.0 |

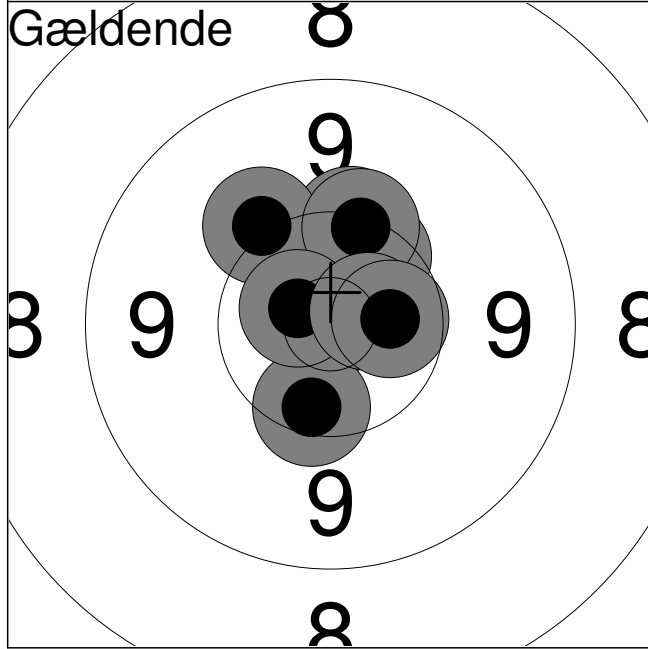

| | | |
|-----|-------|---|
| 11: | 10.4 | ↗ |
| 12: | *10.6 | ↑ |
| 13: | *10.9 | ↑ |
| 14: | 10.2 | ↑ |
| 15: | 10.1 | ↗ |
| 16: | 10.2 | ↑ |
| 17: | 10.3 | ↓ |
| 18: | *10.7 | ↖ |
| 19: | *10.7 | → |
| 20: | *10.5 | → |

| | |
|-------|-------|
| Serie | 100.0 |
| Total | 200.0 |

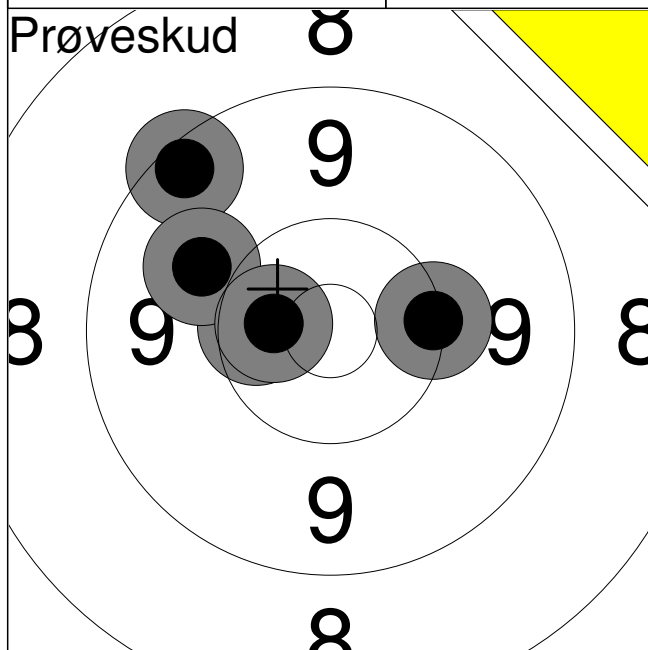

| | | |
|----|-------|---|
| 1: | 9.4 | ↗ |
| 2: | *10.4 | ← |
| 3: | 9.9 | ↗ |
| 4: | *10.5 | ← |
| 5: | 10.2 | → |

| | |
|-------|------|
| Serie | 48.0 |
| Total | 0.0 |

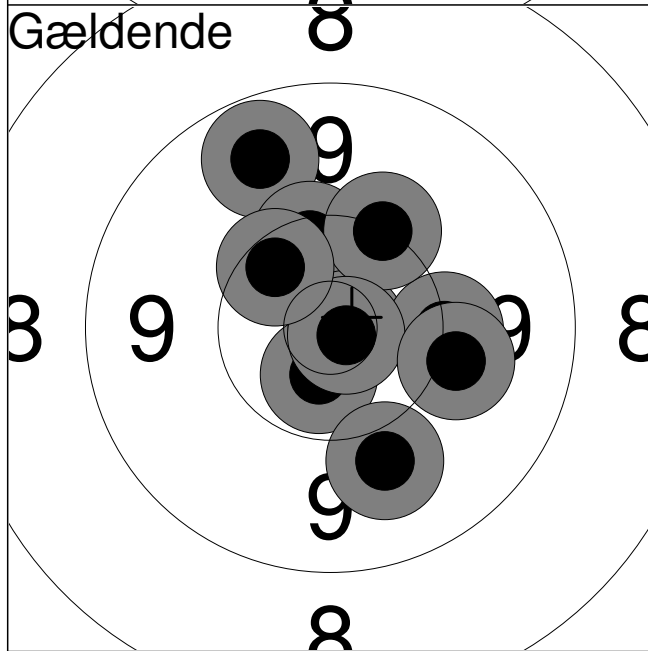

| | | |
|-----|-------|---|
| 1: | 9.6 | ↗ |
| 2: | 10.3 | ↗ |
| 3: | *10.6 | ↘ |
| 4: | *10.8 | → |
| 5: | 10.1 | → |
| 6: | 10.2 | ↗ |
| 7: | *10.8 | ↘ |
| 8: | 10.0 | → |
| 9: | 10.4 | ↗ |
| 10: | 9.9 | ↘ |

| | |
|-------|------|
| Serie | 98.0 |
| Total | 98.0 |

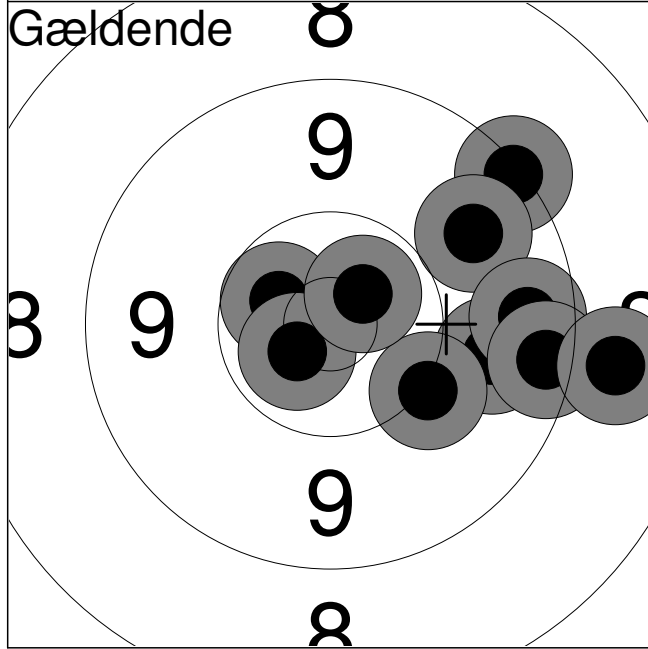

| | | |
|-----|-------|---|
| 11: | 9.2 | ↗ |
| 12: | 9.7 | ↗ |
| 13: | 9.8 | → |
| 14: | 9.5 | → |
| 15: | *10.6 | ↗ |
| 16: | 9.4 | → |
| 17: | 8.8 | → |
| 18: | 10.1 | ↘ |
| 19: | *10.6 | ↙ |
| 20: | *10.6 | ↗ |

| | |
|-------|-------|
| Serie | 93.0 |
| Total | 191.0 |

| | | | |
|------|-------|-------------------|--|
| Hold | Skive | Nikoline Svendsen | |
| 17 | 3 | | |

| | | |
|-----|---------------------|----|
| 50m | Vester Hassing Skf. | J2 |
|-----|---------------------|----|

| | | |
|---------------|------------------|---------------------|
| 29/5-2/6 2013 | Jeppestævne 2013 | Aalborg Skyttekreds |
|---------------|------------------|---------------------|

| | |
|---------------------------------|--------------------------------|
| Ant. obligatoriske træningsskud | Arrangørlagets navn og stempel |
|---------------------------------|--------------------------------|

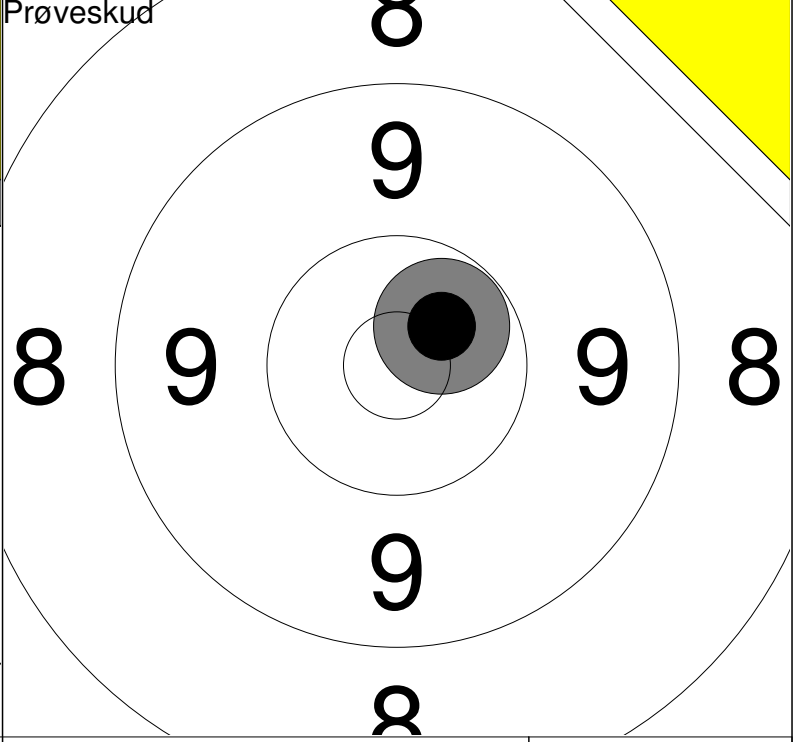
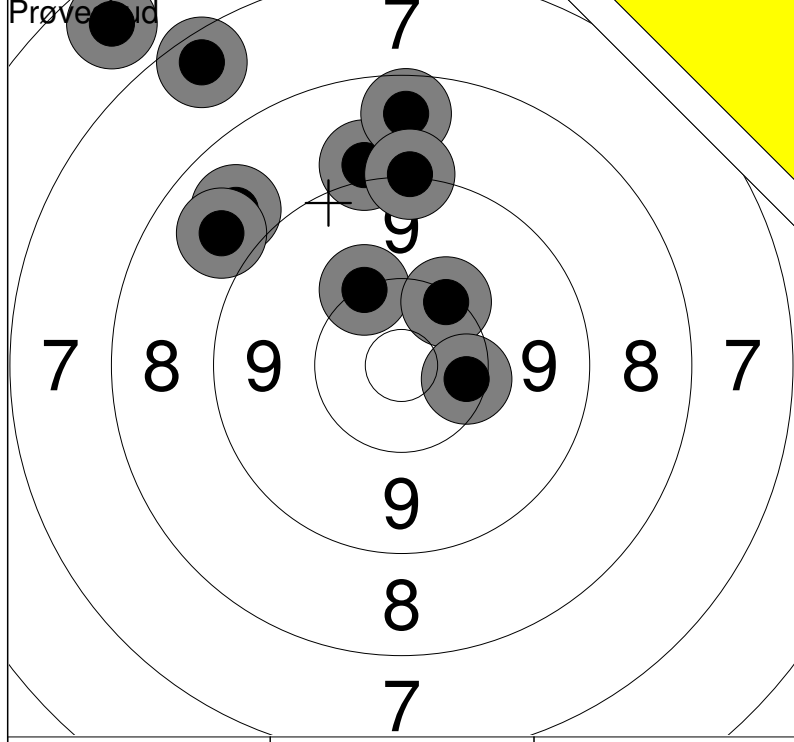

| | | | |
|-----------|------------|-------|----|
| 1: 7.5 ↗ | 6: 10.2 ↗ | Serie | 85 |
| 2: 10.2 ↗ | 7: 9.1 ↑ | | |
| 3: 6.6 ↗ | 8: 8.8 ↗ | Total | 0 |
| 4: 9.0 ↑ | 9: 8.8 ↗ | | |
| 5: 8.5 ↑ | 10: 10.3 ↘ | | |

| | | |
|-------------|-------|----|
| 11: *10.6 ↗ | Serie | 10 |
| | Total | 0 |

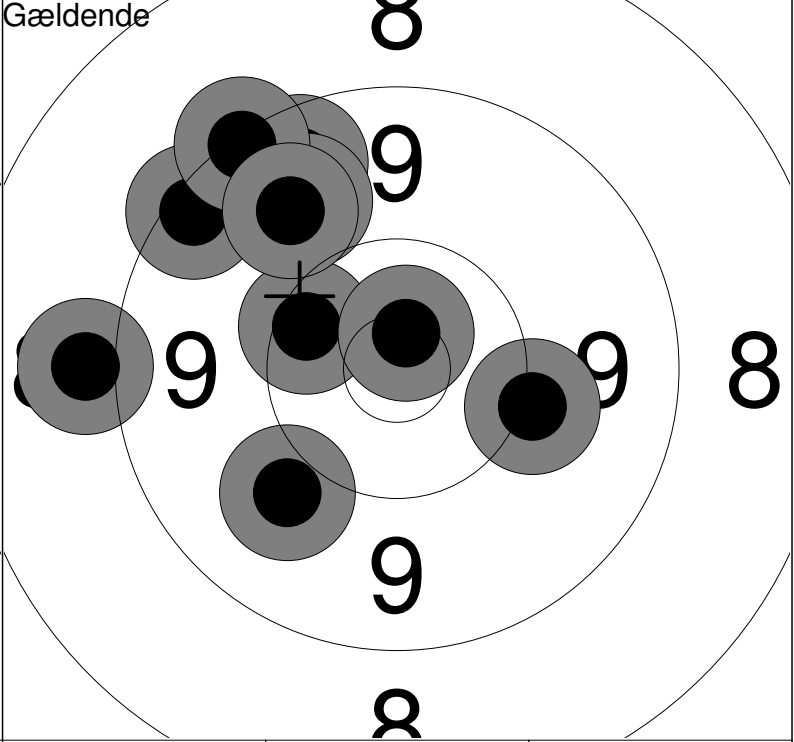
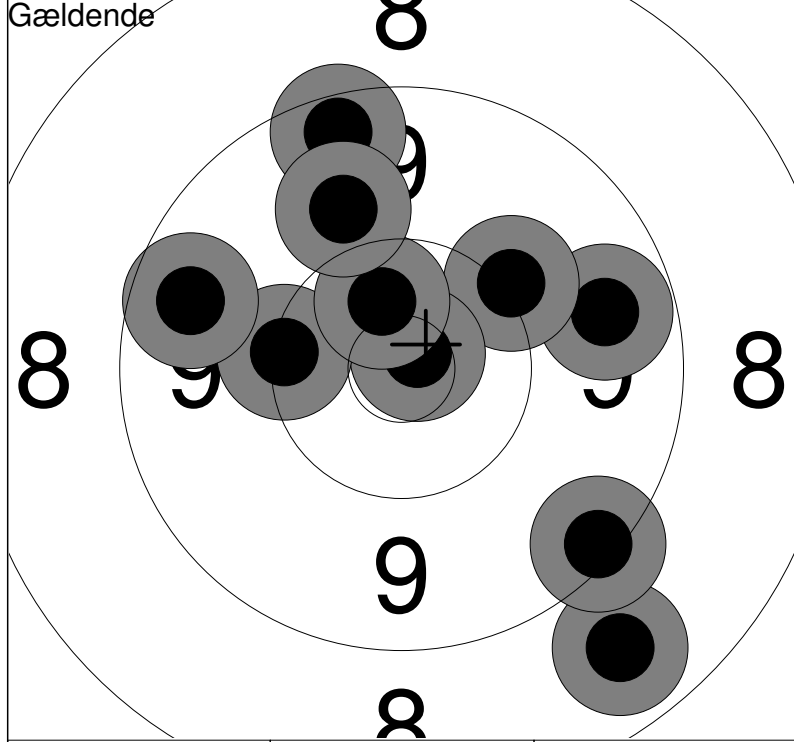

| | | | |
|-----------|------------|-------|----|
| 1: 8.7 ↘ | 6: *10.8 ↗ | Serie | 93 |
| 2: 9.3 ↘ | 7: 10.2 ← | | |
| 3: 9.6 → | 8: *10.5 ↑ | Total | 93 |
| 4: 10.1 ↗ | 9: 9.9 ↑ | | |
| 5: 9.4 ↑ | 10: 9.6 ← | | |

| | | | |
|------------|-------------|-------|-----|
| 11: 9.0 ← | 16: 10.1 → | Serie | 93 |
| 12: 9.9 ↘ | 17: *10.7 ↑ | | |
| 13: 9.5 ↗ | 18: 9.3 ↗ | Total | 186 |
| 14: 9.8 ↗ | 19: 9.2 ↗ | | |
| 15: 10.3 ← | 20: 9.8 ↗ | | |

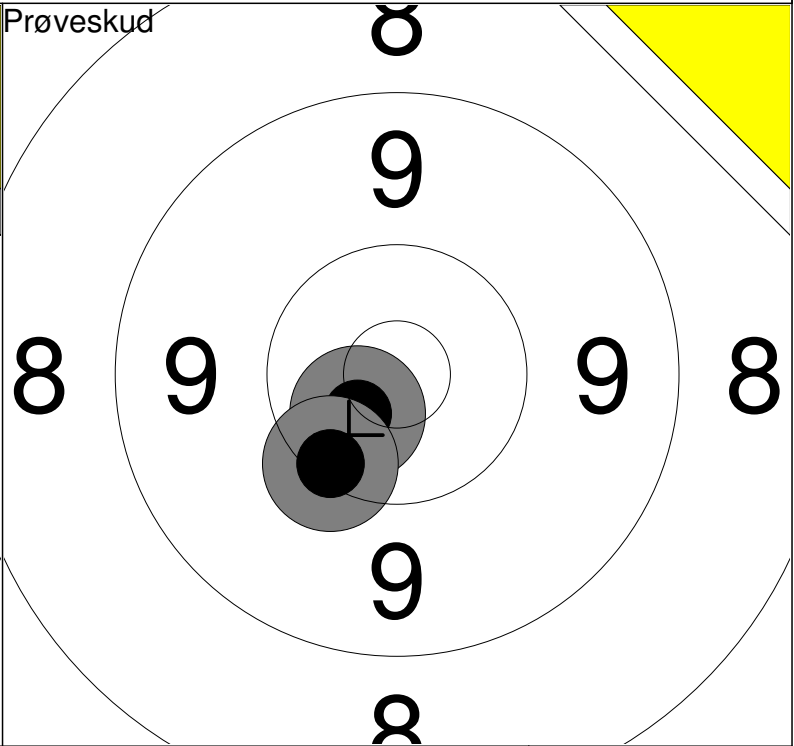
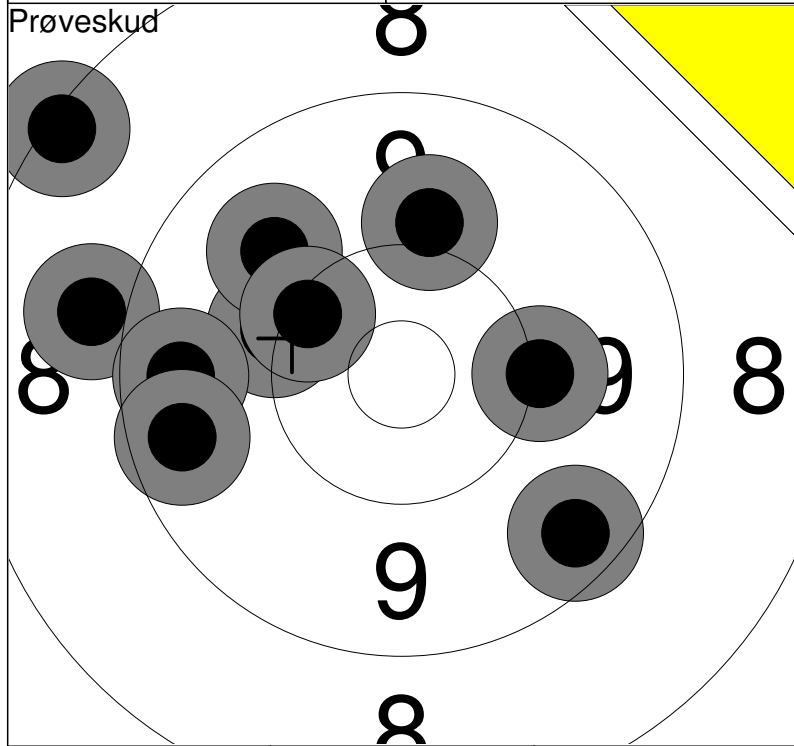

| | | | |
|-----------|-----------|-------|----|
| 1: 10.1 ↙ | 6: 10.0 ↑ | Serie | 92 |
| 2: 8.3 ↗ | 7: 9.9 ↗ | | |
| 3: 8.9 ↖ | 8: 10.3 ↗ | Total | 0 |
| 4: 9.6 ↖ | 9: 10.1 → | | |
| 5: 9.5 ↖ | 10: 9.5 ↘ | | |

| | | |
|-------------|-------|----|
| 11: *10.6 ↘ | Serie | 20 |
| 12: 10.3 ↘ | | |
| Total | | 0 |

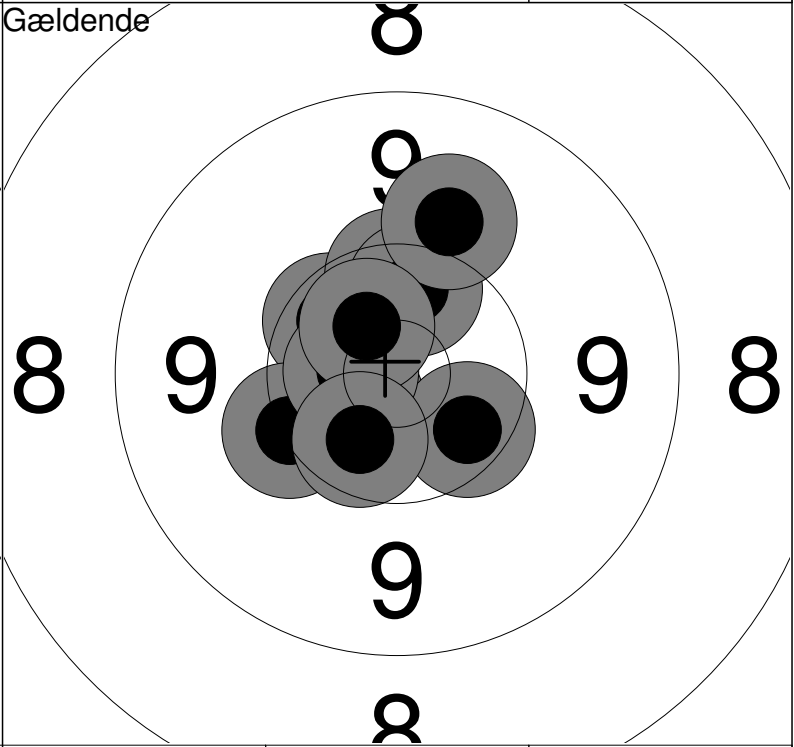
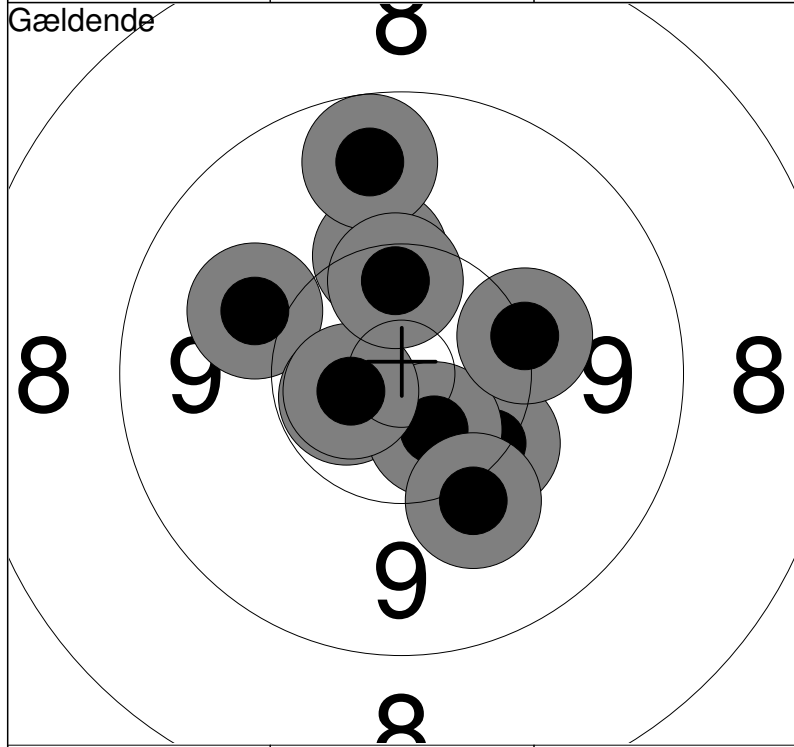

| | | | |
|------------|------------|-------|----|
| 1: 10.3 ↘ | 6: *10.6 ↖ | Serie | 99 |
| 2: 10.0 ↖ | 7: 10.2 → | | |
| 3: *10.6 ↖ | 8: 10.2 ↑ | Total | 99 |
| 4: *10.6 ↘ | 9: 9.6 ↑ | | |
| 5: 10.1 ↘ | 10: 10.4 ↑ | | |

| | | | |
|-------------|-------------|-------|-----|
| 11: *10.4 ↖ | 16: 10.2 ↖ | Serie | 100 |
| 12: *10.6 ↖ | 17: 10.4 ↘ | | |
| 13: 10.4 ↑ | 18: *10.7 ↖ | Total | 199 |
| 14: *10.4 ↑ | 19: *10.6 ↗ | | |
| 15: 10.0 ↑ | 20: *10.5 ↘ | | |

| | | |
|-------------------|-------------------|----------------------|
| Hold 17 | Skive 6 | Simon Vissing |
|-------------------|-------------------|----------------------|

| | | |
|-----|-------------------------|-----|
| 50m | Hjørring Skytteforening | MUN |
|-----|-------------------------|-----|

| | | |
|---------------|------------------|---------------------|
| 29/5-2/6 2013 | Jeppestævne 2013 | Aalborg Skyttekreds |
|---------------|------------------|---------------------|

| | |
|---------------------------------|-------------------------------|
| Ant. obligatoriske træningsskud | Arrangørlaget navn og stempel |
|---------------------------------|-------------------------------|

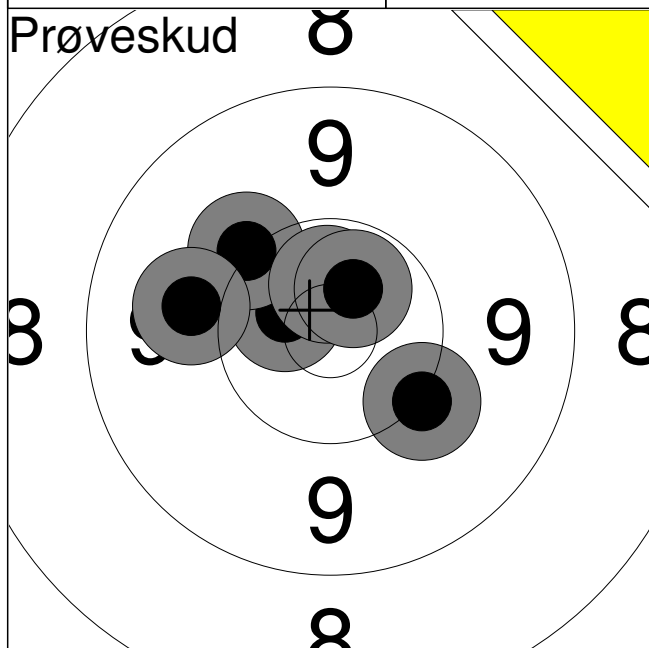

| | | |
|----|-------|---|
| 1: | *10.6 | ↖ |
| 2: | 10.1 | ↗ |
| 3: | 10.0 | ↖ |
| 4: | *10.6 | ↑ |
| 5: | 10.1 | ↘ |
| 6: | *10.6 | ↗ |

| | |
|-------|------|
| Serie | 60.0 |
|-------|------|

| | |
|-------|-----|
| Total | 0.0 |
|-------|-----|

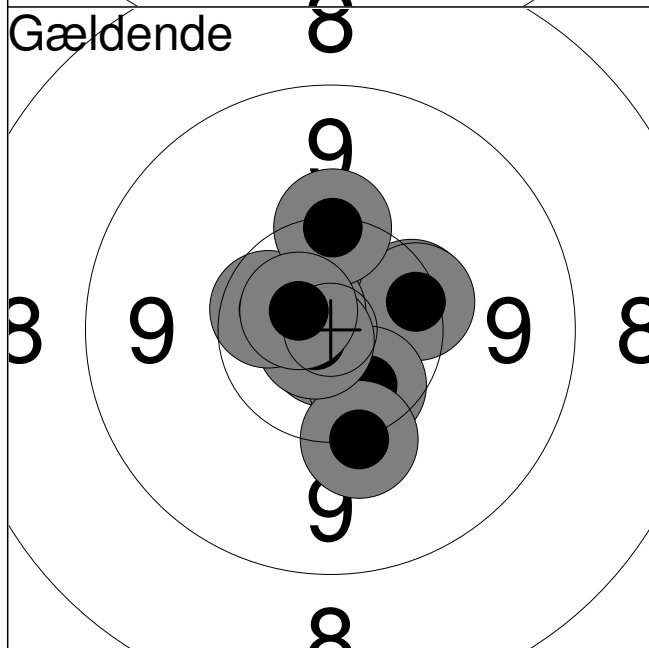

| | | |
|-----|-------|---|
| 1: | *10.8 | ↓ |
| 2: | 10.3 | → |
| 3: | 10.3 | → |
| 4: | *10.5 | ↘ |
| 5: | 10.2 | ↘ |
| 6: | *10.7 | ↗ |
| 7: | *10.8 | ↙ |
| 8: | *10.5 | ↖ |
| 9: | 10.2 | ↑ |
| 10: | *10.7 | ↖ |

| | |
|-------|-------|
| Serie | 100.0 |
|-------|-------|

| | |
|-------|-------|
| Total | 100.0 |
|-------|-------|

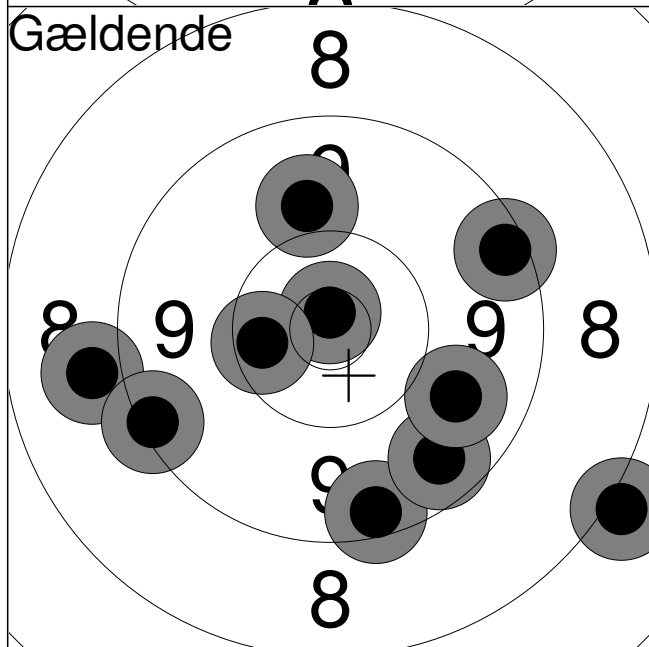

| | | |
|-----|-------|---|
| 11: | 9.4 | ↓ |
| 12: | 8.9 | ← |
| 13: | 8.0 | ↘ |
| 14: | 9.4 | → |
| 15: | 9.3 | ↙ |
| 16: | 9.9 | ↑ |
| 17: | 9.6 | ↘ |
| 18: | 9.8 | ↘ |
| 19: | *10.8 | ↑ |
| 20: | 10.4 | ← |

| | |
|-------|------|
| Serie | 90.0 |
|-------|------|

| | |
|-------|-------|
| Total | 190.0 |
|-------|-------|

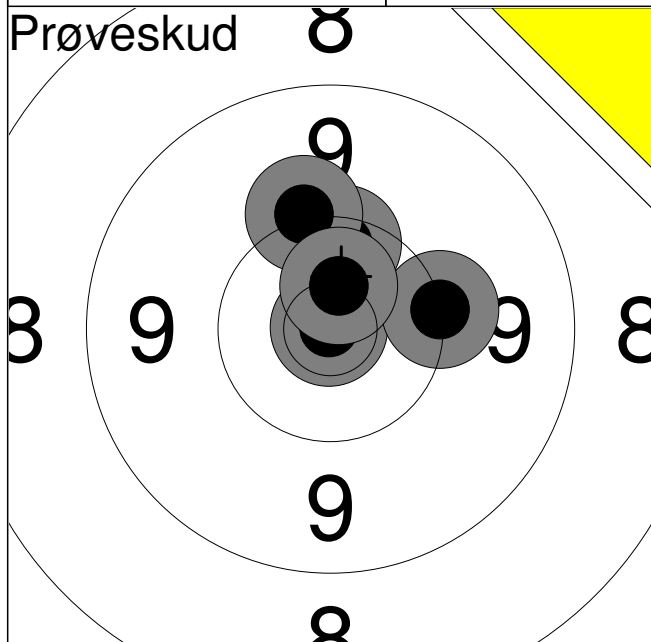

| | | |
|-------|-------|------|
| 1: | *10.9 | ↗ |
| 2: | 10.3 | ↑ |
| 3: | 10.1 | ↑ |
| 4: | 10.2 | → |
| 5: | *10.6 | ↑ |
| Serie | | 50.0 |
| Total | | 0.0 |

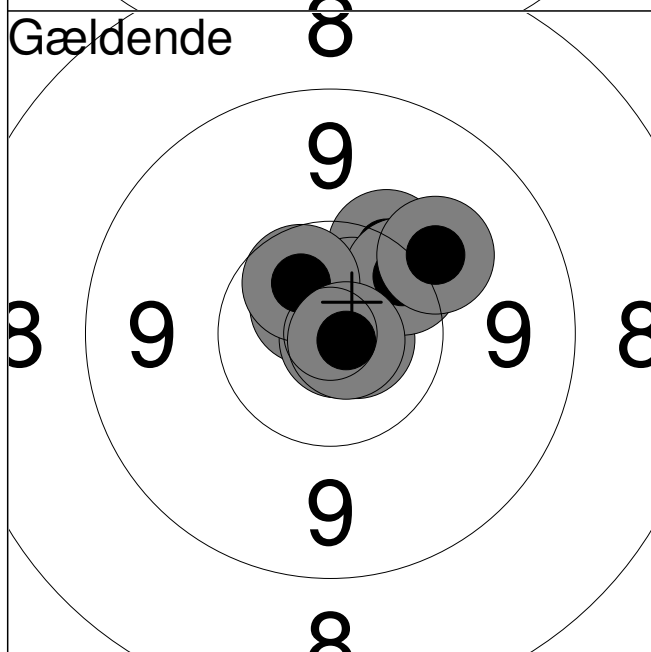

| | | |
|-------|-------|-------|
| 1: | *10.7 | ↑ |
| 2: | 10.2 | ↗ |
| 3: | *10.6 | ↗ |
| 4: | *10.7 | ↗ |
| 5: | *10.9 | ↓ |
| 6: | *10.8 | → |
| 7: | 10.3 | ↗ |
| 8: | *10.5 | ↗ |
| 9: | 10.0 | ↗ |
| 10: | *10.8 | ↓ |
| Serie | | 100.0 |
| Total | | 100.0 |

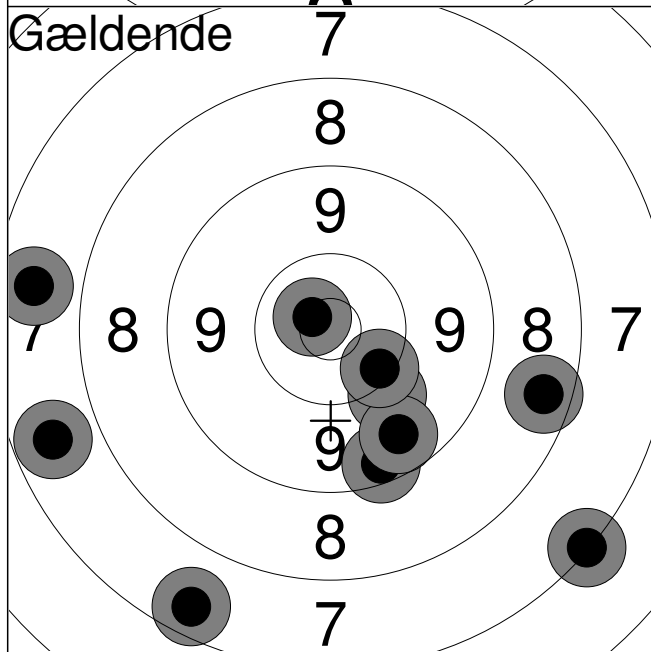

| | | |
|-------|-------|-------|
| 11: | *10.7 | ↗ |
| 12: | 7.5 | ↓ |
| 13: | 7.6 | ← |
| 14: | 9.4 | ↓ |
| 15: | 7.2 | ↓ |
| 16: | 10.0 | ↓ |
| 17: | 8.5 | → |
| 18: | 7.6 | ← |
| 19: | 9.6 | ↓ |
| 20: | 10.3 | ↓ |
| Serie | | 84.0 |
| Total | | 184.0 |

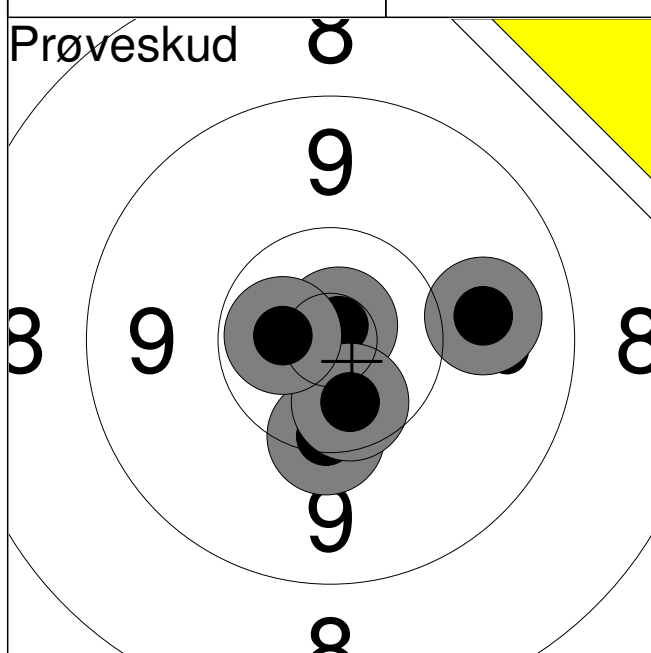

| | | |
|----|-------|---|
| 1: | *10.8 | ↗ |
| 2: | 10.3 | ↓ |
| 3: | *10.5 | ↓ |
| 4: | 9.9 | → |
| 5: | *10.6 | ← |

| | |
|-------|------|
| Serie | 49.0 |
| Total | 0.0 |

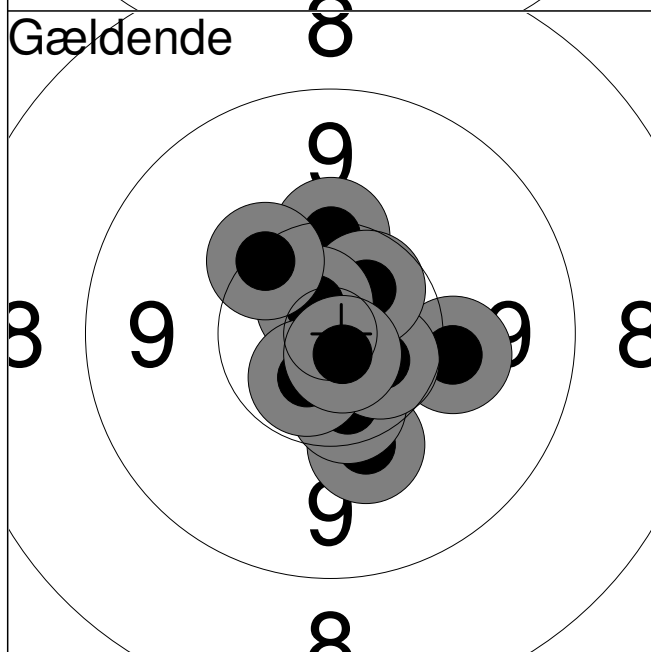

| | | |
|-----|-------|---|
| 1: | 10.1 | ↓ |
| 2: | 10.1 | → |
| 3: | *10.4 | ↓ |
| 4: | 10.3 | ↑ |
| 5: | *10.6 | ↘ |
| 6: | *10.5 | ↗ |
| 7: | *10.7 | ↗ |
| 8: | *10.6 | ↘ |
| 9: | *10.8 | ↓ |
| 10: | 10.3 | ↗ |

| | |
|-------|-------|
| Serie | 100.0 |
| Total | 100.0 |

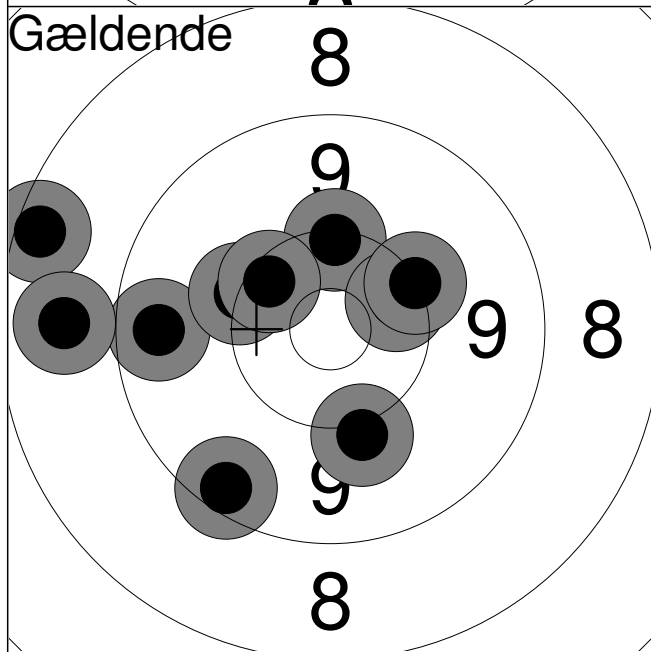

| | | |
|-----|------|---|
| 11: | 10.2 | ↑ |
| 12: | 9.5 | ← |
| 13: | 10.1 | ↓ |
| 14: | 8.4 | ↗ |
| 15: | 8.7 | ← |
| 16: | 10.2 | ↗ |
| 17: | 9.4 | ↘ |
| 18: | 10.4 | ↗ |
| 19: | 10.3 | ↗ |
| 20: | 10.2 | ↗ |

| | |
|-------|-------|
| Serie | 94.0 |
| Total | 194.0 |

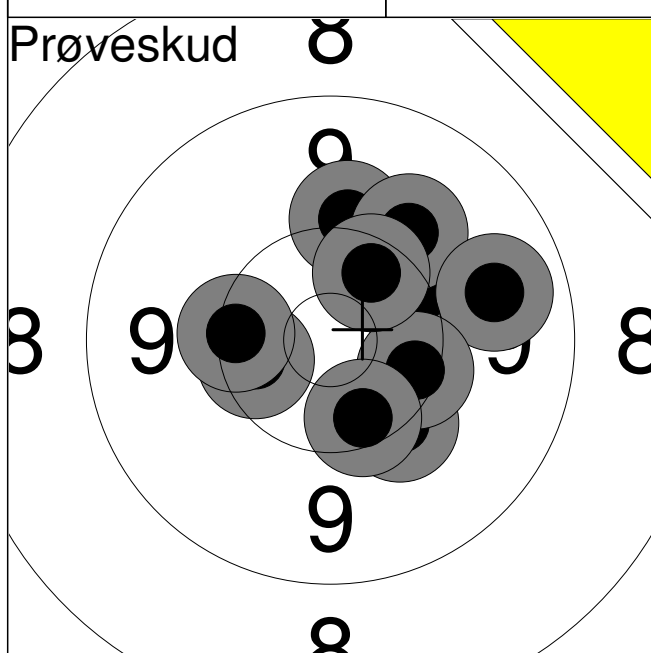

| | | |
|-----|------|---|
| 1: | 10.4 | ← |
| 2: | 10.1 | ↑ |
| 3: | 10.3 | ← |
| 4: | 10.3 | → |
| 5: | 10.0 | ↗ |
| 6: | 10.2 | ↘ |
| 7: | 9.7 | → |
| 8: | 10.3 | → |
| 9: | 10.4 | ↗ |
| 10: | 10.4 | ↘ |

| | |
|-------|------|
| Serie | 99.0 |
|-------|------|

| | |
|-------|-----|
| Total | 0.0 |
|-------|-----|

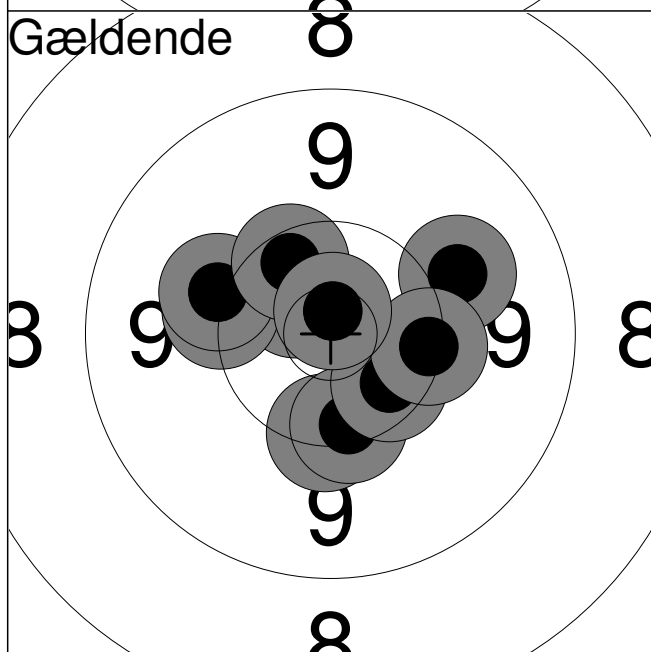

| | | |
|-----|-------|---|
| 1: | *10.6 | ↗ |
| 2: | 10.2 | ← |
| 3: | 10.3 | ↘ |
| 4: | 10.3 | ↘ |
| 5: | 10.1 | ↗ |
| 6: | 10.0 | → |
| 7: | 10.4 | ↗ |
| 8: | 10.4 | ↘ |
| 9: | 10.3 | → |
| 10: | *10.8 | ↑ |

| | |
|-------|-------|
| Serie | 100.0 |
|-------|-------|

| | |
|-------|-------|
| Total | 100.0 |
|-------|-------|

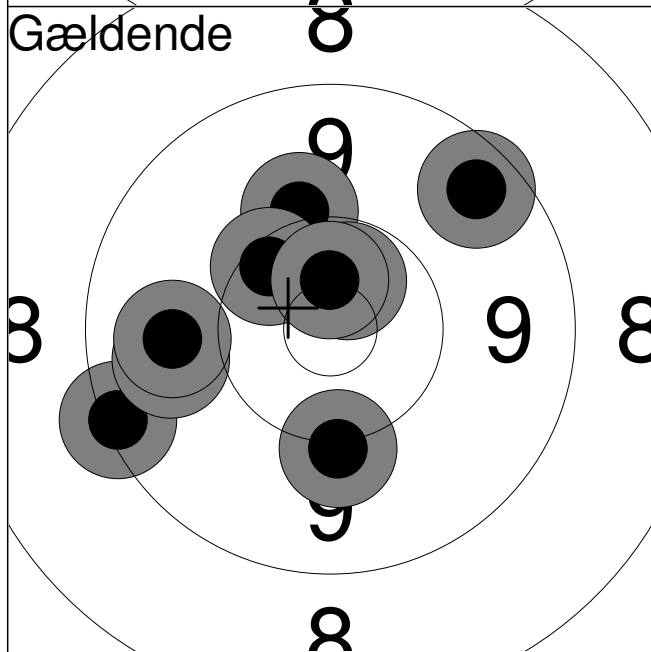

| | | |
|-----|-------|---|
| 11: | 9.5 | ↗ |
| 12: | 9.3 | ← |
| 13: | 10.2 | ↑ |
| 14: | 10.1 | ↘ |
| 15: | 10.1 | ↗ |
| 16: | *10.6 | ↗ |
| 17: | 9.8 | ← |
| 18: | 10.3 | ↗ |
| 19: | 9.8 | ← |
| 20: | *10.6 | ↑ |

| | |
|-------|------|
| Serie | 96.0 |
|-------|------|

| | |
|-------|-------|
| Total | 196.0 |
|-------|-------|

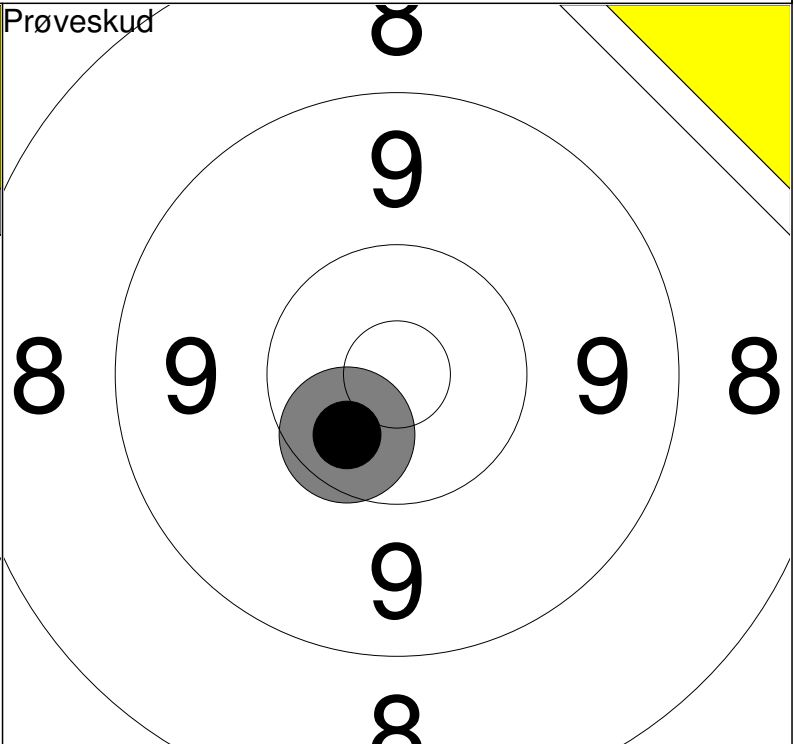
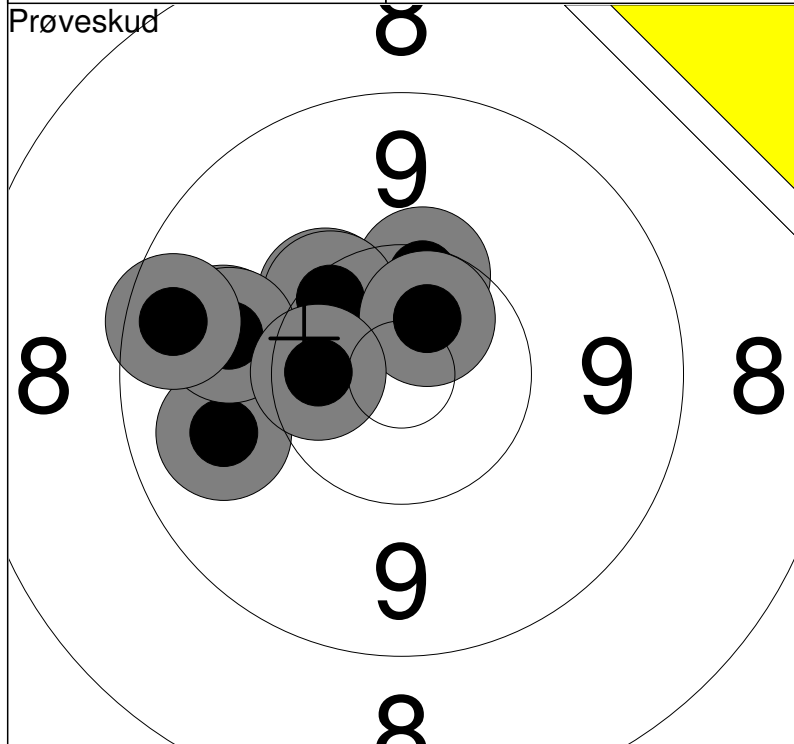

| | | | |
|------------|------------|-------|----|
| 1: 10.3 ↑ | 6: *10.6 ↑ | Serie | 96 |
| 2: *10.4 ↖ | 7: 9.8 ← | | |
| 3: 10.3 ↗ | 8: 9.9 ← | Total | 0 |
| 4: 10.3 ↗ | 9: *10.4 ← | | |
| 5: 9.8 ← | 10: 9.5 ← | | |

| | | |
|-------------|-------|----|
| 11: *10.5 ↓ | Serie | 10 |
| | | |
| | Total | 0 |
| | | |

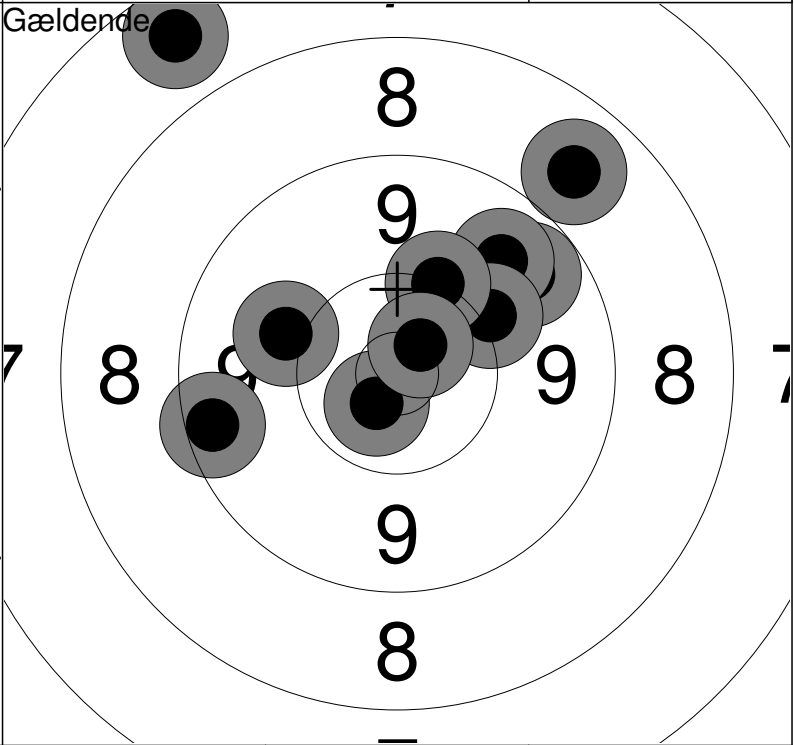
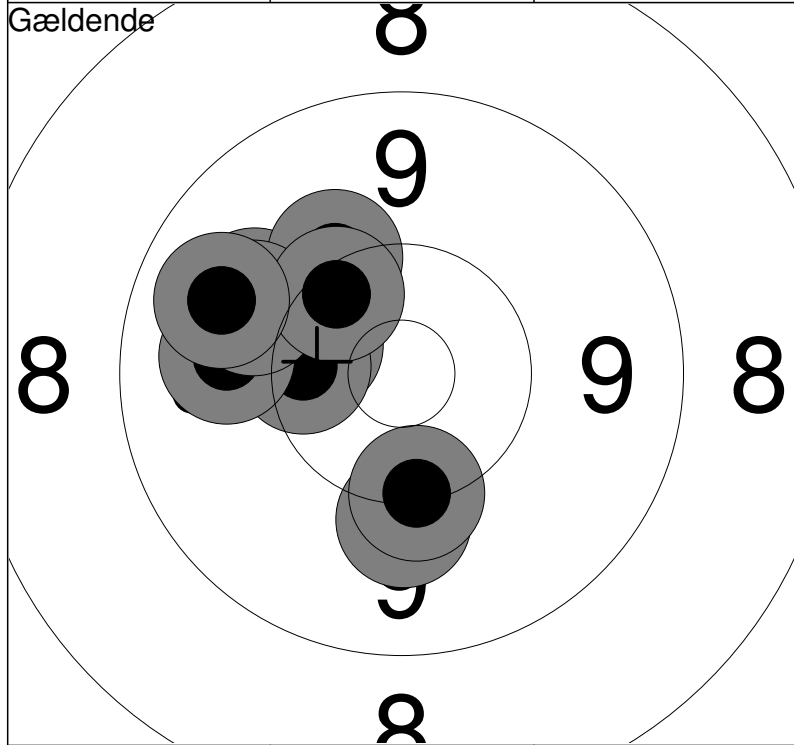

| | | | |
|-----------|------------|-------|----|
| 1: 10.4 ← | 6: 10.1 ↑ | Serie | 97 |
| 2: 10.3 ← | 7: 10.0 ← | | |
| 3: 9.9 ← | 8: 10.3 ↗ | Total | 97 |
| 4: 9.9 ← | 9: 9.7 ← | | |
| 5: 10.1 ↓ | 10: 10.2 ↓ | | |

| | | | |
|-----------|-------------|-------|-----|
| 11: 9.6 ↗ | 16: 10.1 ↗ | Serie | 92 |
| 12: 8.8 ↗ | 17: *10.7 ↓ | | |
| 13: 9.4 ← | 18: 10.2 ↑ | Total | 189 |
| 14: 7.6 ↖ | 19: *10.7 ↗ | | |
| 15: 9.7 ↗ | 20: 10.0 ← | | |

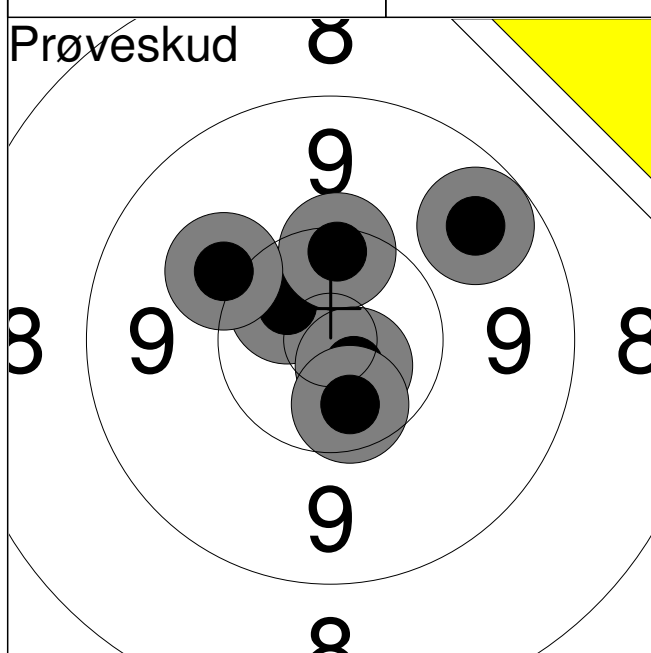

| | | |
|--------------|-------|-------------|
| 1: | *10.6 | ↗ |
| 2: | 10.3 | ↑ |
| 3: | *10.7 | ↘ |
| 4: | 10.1 | ↗ |
| 5: | 9.6 | ↗ |
| 6: | *10.5 | ↘ |
| Serie | | 59.0 |
| Total | | 0.0 |

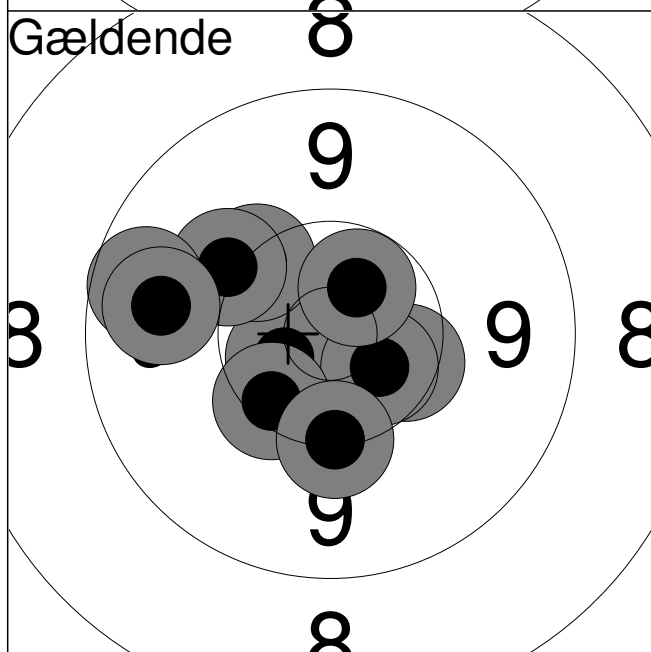

| | | |
|--------------|-------|-------------|
| 1: | *10.6 | ↖ |
| 2: | 10.2 | ↗ |
| 3: | 10.4 | ↘ |
| 4: | *10.5 | ↘ |
| 5: | 10.3 | ↖ |
| 6: | 10.1 | ↗ |
| 7: | 10.2 | ↘ |
| 8: | *10.6 | ↗ |
| 9: | 9.6 | ↖ |
| 10: | 9.7 | ↖ |
| Serie | | 98.0 |
| Total | | 98.0 |

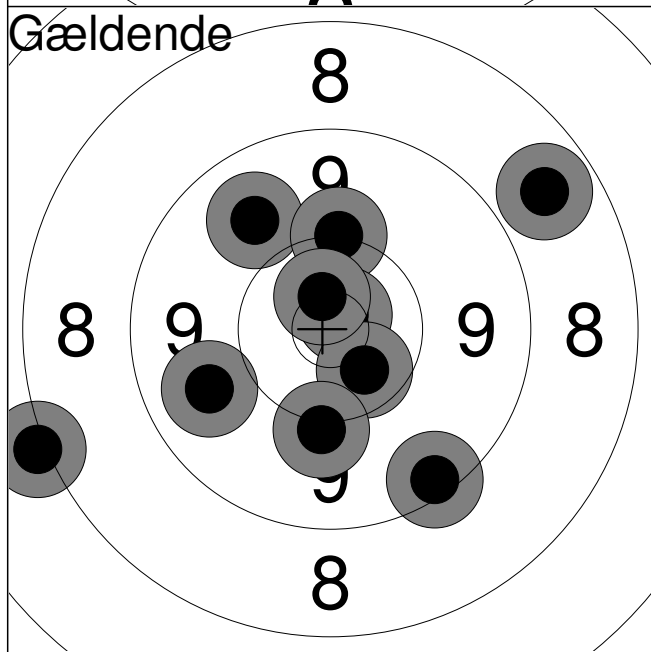

| | | |
|--------------|-------|--------------|
| 11: | 8.1 | ↖ |
| 12: | 9.8 | ↗ |
| 13: | 9.3 | ↘ |
| 14: | 10.1 | ↑ |
| 15: | *10.8 | ↗ |
| 16: | *10.5 | ↘ |
| 17: | 10.1 | ↘ |
| 18: | 8.7 | ↗ |
| 19: | *10.7 | ↑ |
| 20: | 9.8 | ↖ |
| Serie | | 93.0 |
| Total | | 191.0 |

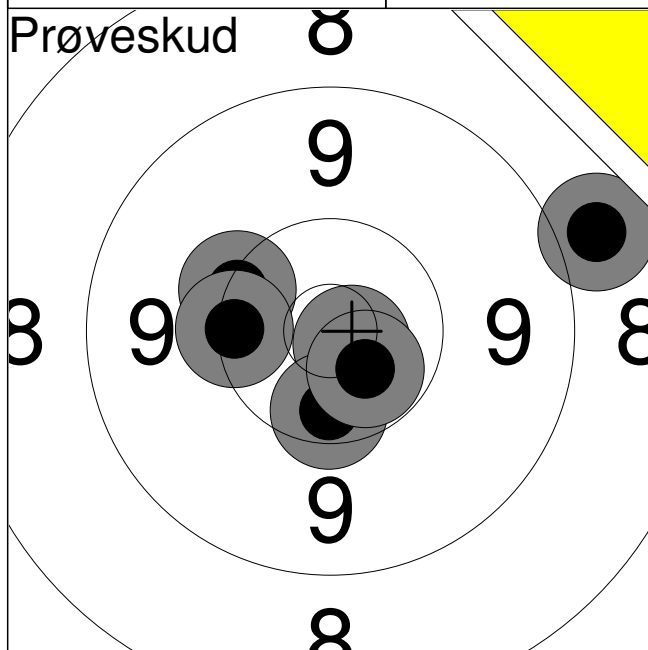

| | | |
|----|-------|---|
| 1: | 8.9 | → |
| 2: | 10.2 | ↗ |
| 3: | *10.8 | ↘ |
| 4: | 10.3 | ← |
| 5: | 10.4 | ↘ |
| 6: | *10.6 | ↘ |

| | |
|-------|------|
| Serie | 58.0 |
|-------|------|

| | |
|-------|-----|
| Total | 0.0 |
|-------|-----|

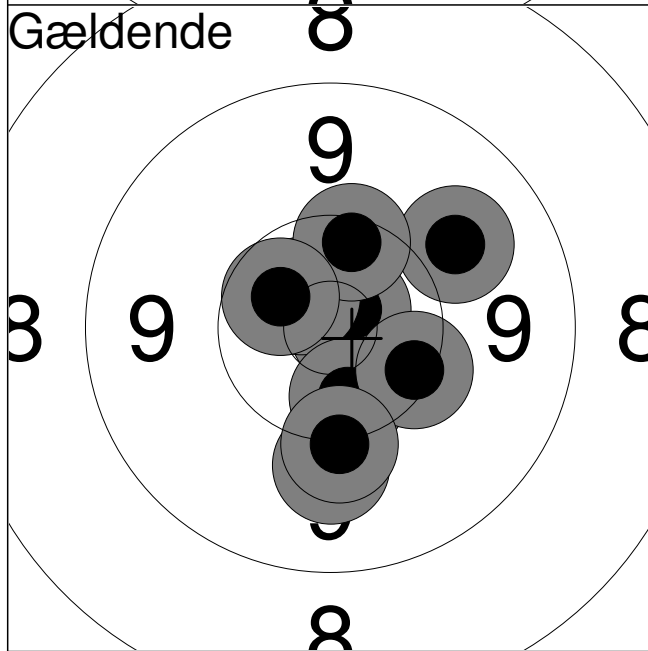

| | | |
|-----|-------|---|
| 1: | 9.9 | ↗ |
| 2: | *10.8 | → |
| 3: | *10.7 | ↗ |
| 4: | *10.7 | ↗ |
| 5: | 10.3 | ↑ |
| 6: | *10.4 | ↘ |
| 7: | *10.5 | ↗ |
| 8: | 10.0 | ↘ |
| 9: | 10.3 | → |
| 10: | 10.1 | ↘ |

| | |
|-------|------|
| Serie | 99.0 |
|-------|------|

| | |
|-------|------|
| Total | 99.0 |
|-------|------|

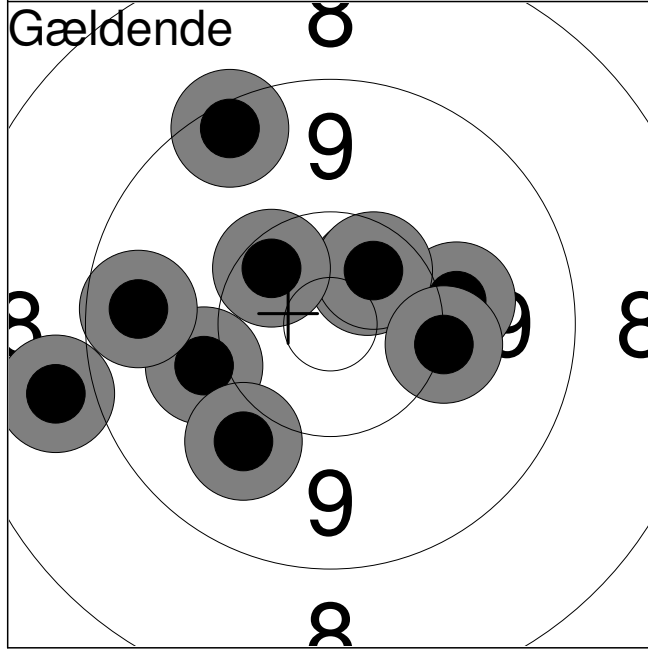

| | | |
|-----|-------|---|
| 11: | 10.0 | → |
| 12: | 8.9 | ← |
| 13: | *10.5 | ↗ |
| 14: | 10.0 | ← |
| 15: | 9.9 | ↘ |
| 16: | *10.5 | ↗ |
| 17: | 10.1 | → |
| 18: | 9.6 | ← |
| 19: | 9.4 | ↗ |
| 20: | 10.4 | ↗ |

| | |
|-------|------|
| Serie | 95.0 |
|-------|------|

| | |
|-------|-------|
| Total | 194.0 |
|-------|-------|

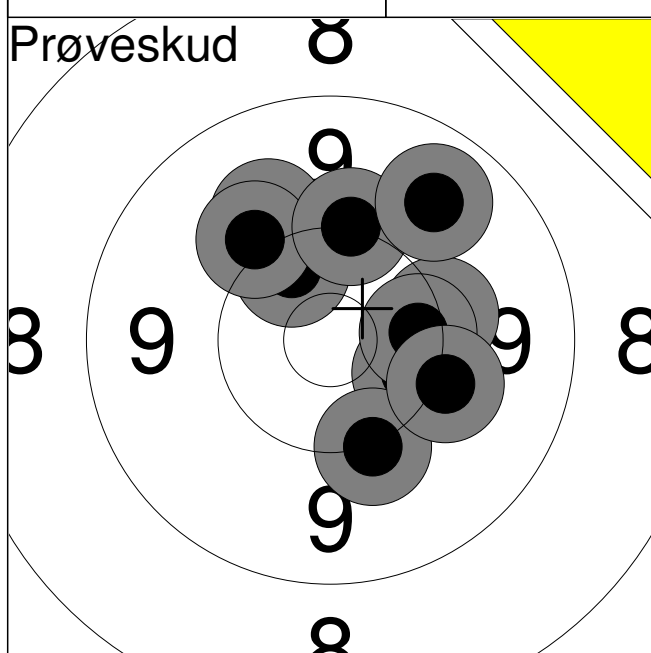

| | | |
|-----|------|---|
| 1: | 10.0 | ↗ |
| 2: | 10.3 | ↘ |
| 3: | 10.2 | → |
| 4: | 10.3 | → |
| 5: | 10.4 | ↗ |
| 6: | 10.1 | ↗ |
| 7: | 10.1 | ↑ |
| 8: | 9.7 | ↗ |
| 9: | 10.1 | ↘ |
| 10: | 10.1 | ↘ |

| | |
|-------|------|
| Serie | 99.0 |
| Total | 0.0 |

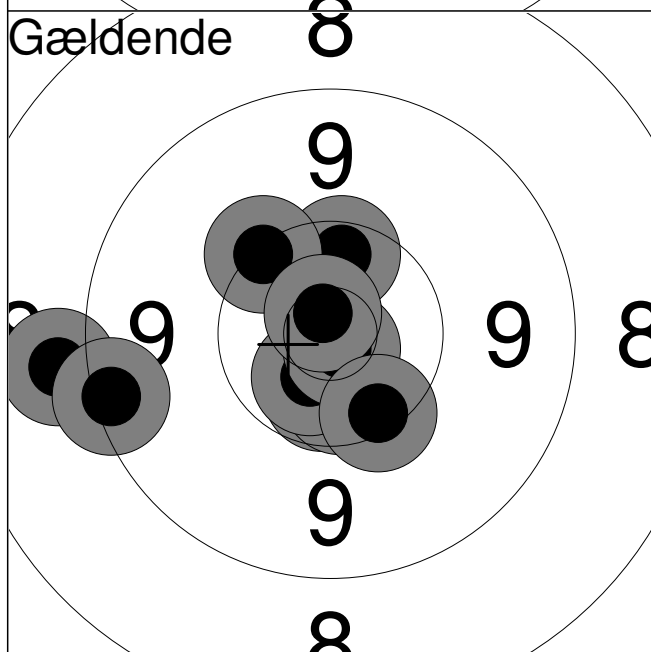

| | | |
|-----|-------|---|
| 1: | *10.5 | ↘ |
| 2: | 10.4 | ↑ |
| 3: | *10.5 | ↘ |
| 4: | *10.6 | ↘ |
| 5: | 8.9 | ← |
| 6: | *10.8 | ↘ |
| 7: | 9.3 | ← |
| 8: | 10.2 | ↗ |
| 9: | *10.8 | ↗ |
| 10: | 10.3 | ↘ |

| | |
|-------|------|
| Serie | 97.0 |
| Total | 97.0 |

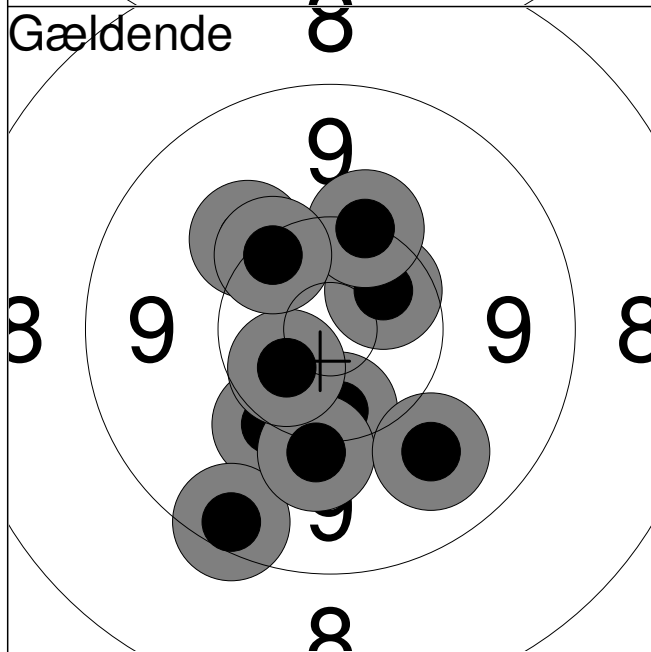

| | | |
|-----|-------|---|
| 11: | 10.1 | ↗ |
| 12: | 10.4 | ↘ |
| 13: | 10.2 | ↘ |
| 14: | 9.4 | ↘ |
| 15: | *10.5 | ↗ |
| 16: | 10.1 | ↘ |
| 17: | *10.5 | ↘ |
| 18: | 9.8 | ↘ |
| 19: | 10.2 | ↗ |
| 20: | 10.3 | ↗ |

| | |
|-------|-------|
| Serie | 98.0 |
| Total | 195.0 |

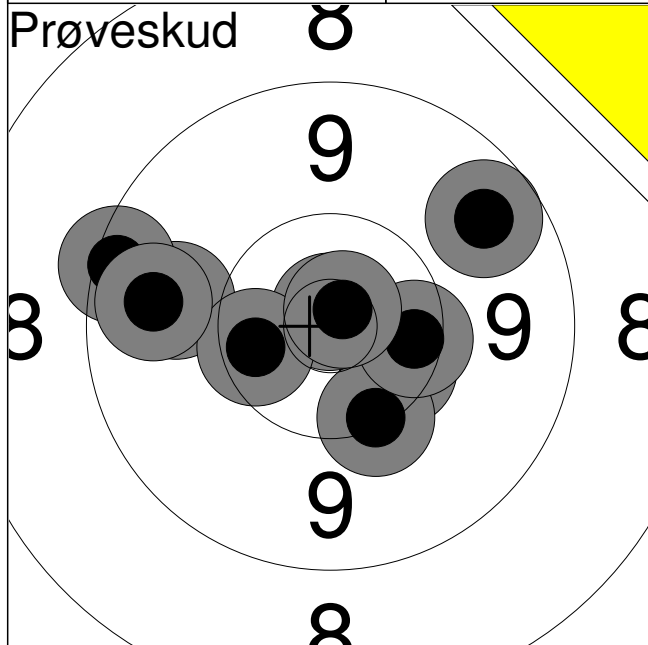

| | | |
|-----|-------|---|
| 1: | 9.6 | ↗ |
| 2: | 10.4 | ↘ |
| 3: | 10.2 | ↘ |
| 4: | 10.4 | → |
| 5: | 9.8 | ↗ |
| 6: | 9.3 | ↗ |
| 7: | *10.8 | ↑ |
| 8: | 10.4 | ← |
| 9: | 9.7 | ← |
| 10: | *10.8 | ↗ |

| | |
|-------|------|
| Serie | 96.0 |
|-------|------|

| | |
|-------|-----|
| Total | 0.0 |
|-------|-----|

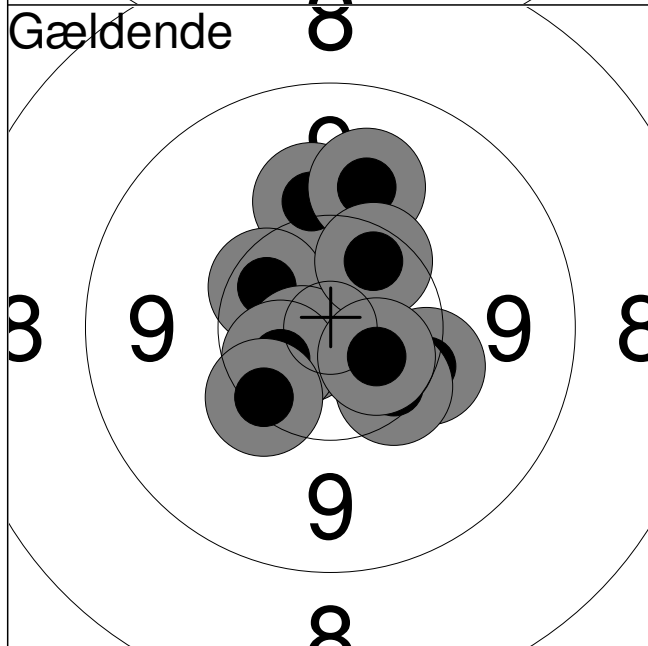

| | | |
|-----|-------|---|
| 1: | 10.1 | ↑ |
| 2: | 9.9 | ↑ |
| 3: | 10.2 | ↘ |
| 4: | *10.4 | ↗ |
| 5: | 10.3 | ↘ |
| 6: | *10.7 | ← |
| 7: | *10.5 | ← |
| 8: | 10.3 | ↘ |
| 9: | 10.4 | ↗ |
| 10: | *10.6 | ↘ |

| | |
|-------|------|
| Serie | 99.0 |
|-------|------|

| | |
|-------|------|
| Total | 99.0 |
|-------|------|

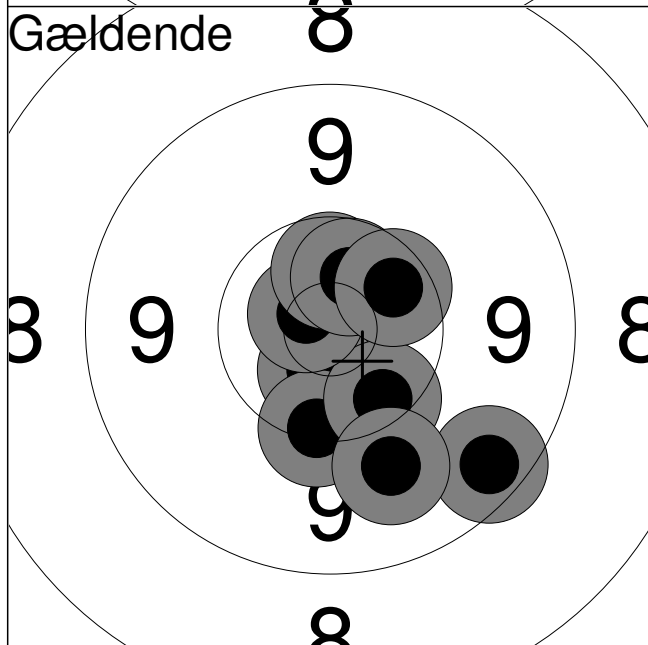

| | | |
|-----|-------|---|
| 11: | *10.6 | ↘ |
| 12: | 9.4 | ↘ |
| 13: | 10.3 | ↘ |
| 14: | 10.2 | ↘ |
| 15: | 10.3 | ↘ |
| 16: | *10.7 | ↗ |
| 17: | *10.5 | ↑ |
| 18: | 9.9 | ↘ |
| 19: | *10.6 | ↗ |
| 20: | *10.4 | ↗ |

| | |
|-------|------|
| Serie | 98.0 |
|-------|------|

| | |
|-------|-------|
| Total | 197.0 |
|-------|-------|

| | | | |
|------|-------|---------------------|--|
| Hold | Skive | Nikolaj Lund Nymann | |
| 18 | 8 | | |

| | | |
|-----|---------------------|-----|
| 50m | Vester Hassing Skf. | MJ1 |
|-----|---------------------|-----|

| | | |
|---------------|------------------|---------------------|
| 29/5-2/6 2013 | Jeppestævne 2013 | Aalborg Skyttekreds |
|---------------|------------------|---------------------|

| | |
|--------------------------------|--------------------------------|
| Ant. obligatoriske træningskud | Arrangørklaget navn og stempel |
|--------------------------------|--------------------------------|

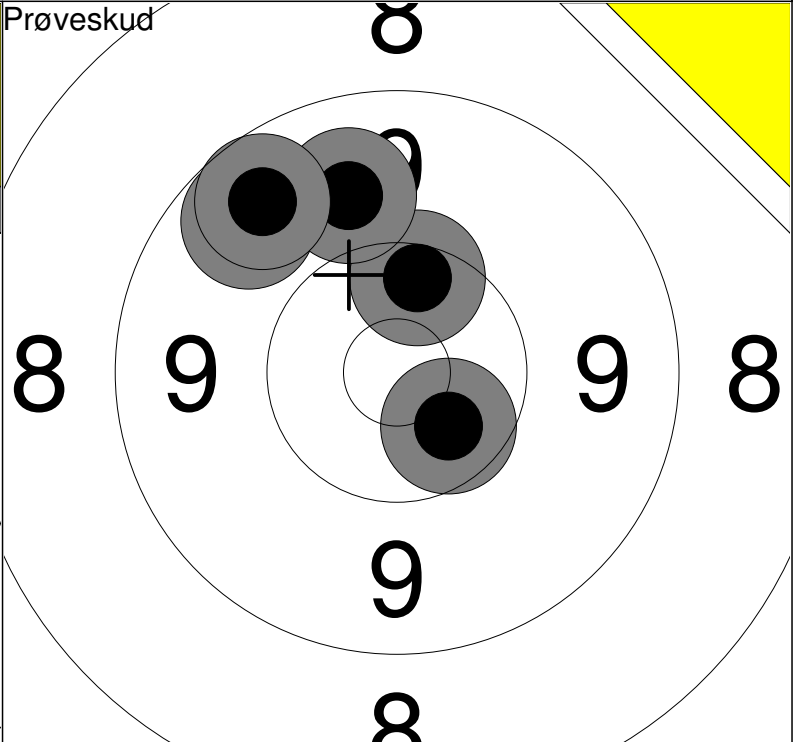
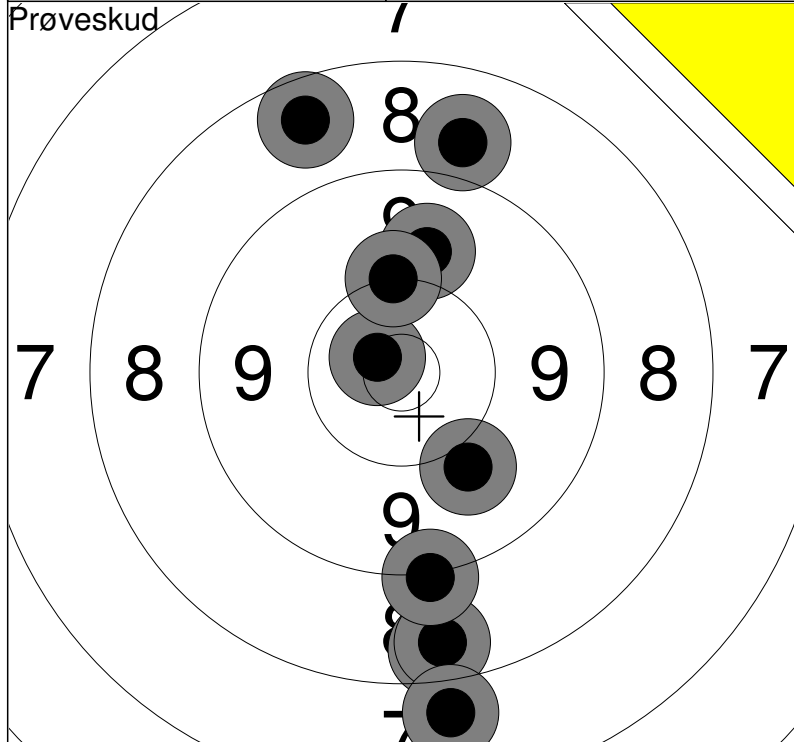

| | | | |
|-----------|------------|-------|----|
| 1: 8.5 ↓ | 6: *10.7 ↖ | Serie | 87 |
| 2: 8.5 ↓ | 7: 9.9 ↑ | | |
| 3: 7.9 ↓ | 8: 10.2 ↑ | Total | 0 |
| 4: 9.1 ↓ | 9: 8.6 ↑ | | |
| 5: 10.0 ↘ | 10: 8.8 ↑ | | |

| | | |
|-------------|-------|----|
| 11: 10.4 ↑ | Serie | 47 |
| 12: 9.6 ↗ | | |
| 13: *10.5 ↘ | Total | 0 |
| 14: 9.8 ↑ | | |
| 15: 9.6 ↗ | | |

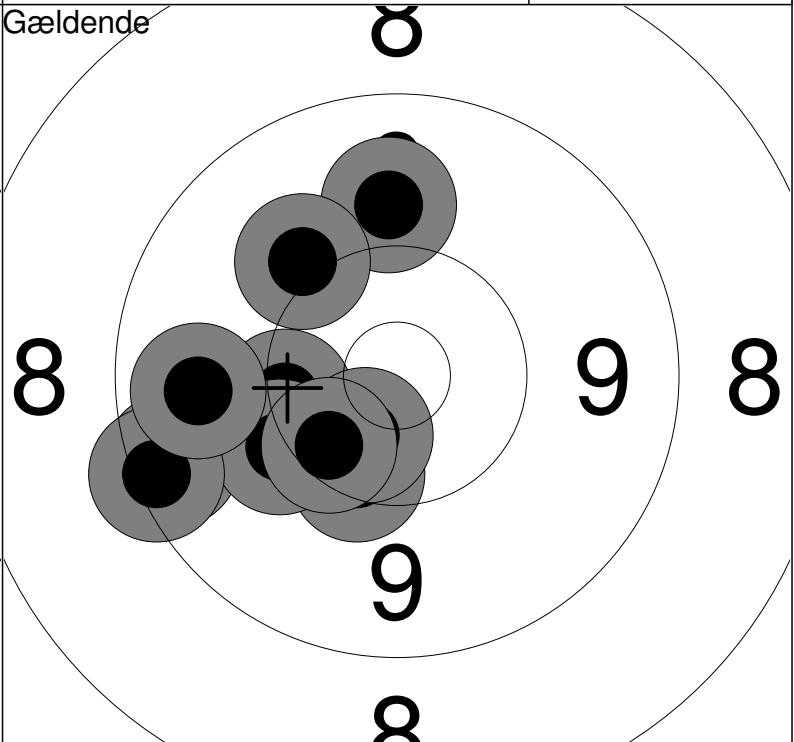
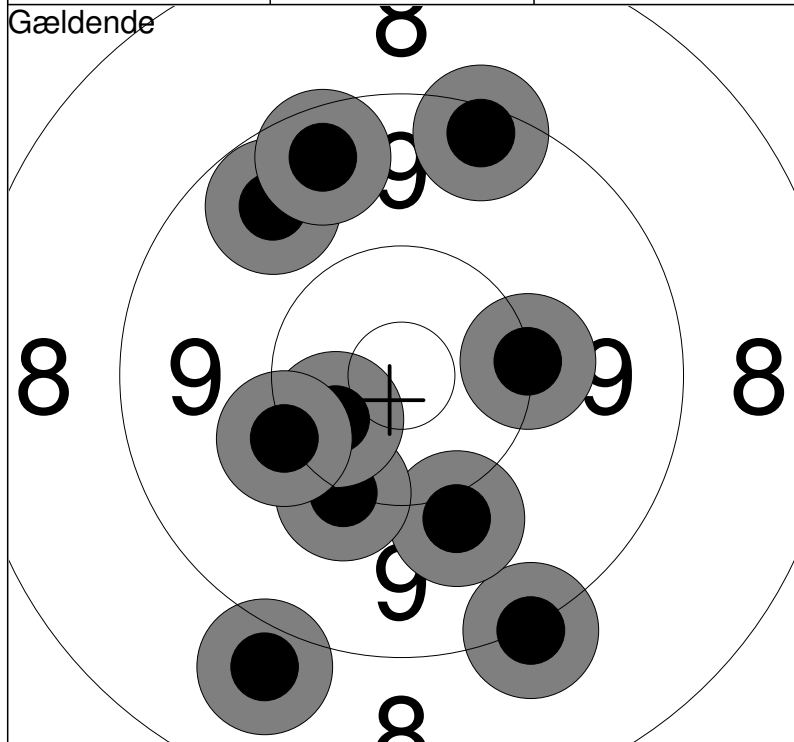

| | | | |
|-----------|------------|-------|----|
| 1: 9.1 ↓ | 6: 8.9 ↓ | Serie | 94 |
| 2: 10.0 ↓ | 7: 9.6 ↗ | | |
| 3: 10.2 → | 8: *10.5 ↘ | Total | 94 |
| 4: 9.3 ↑ | 9: 10.1 ↖ | | |
| 5: 10.2 ↓ | 10: 9.5 ↑ | | |

| | | | |
|-------------|------------|-------|-----|
| 11: 9.5 ↖ | 16: 10.1 ↖ | Serie | 96 |
| 12: 10.3 ↖ | 17: 9.3 ↖ | | |
| 13: 10.3 ↓ | 18: 9.7 ↖ | Total | 190 |
| 14: *10.5 ↘ | 19: 10.0 ↗ | | |
| 15: 9.9 ↑ | 20: 10.4 ↘ | | |

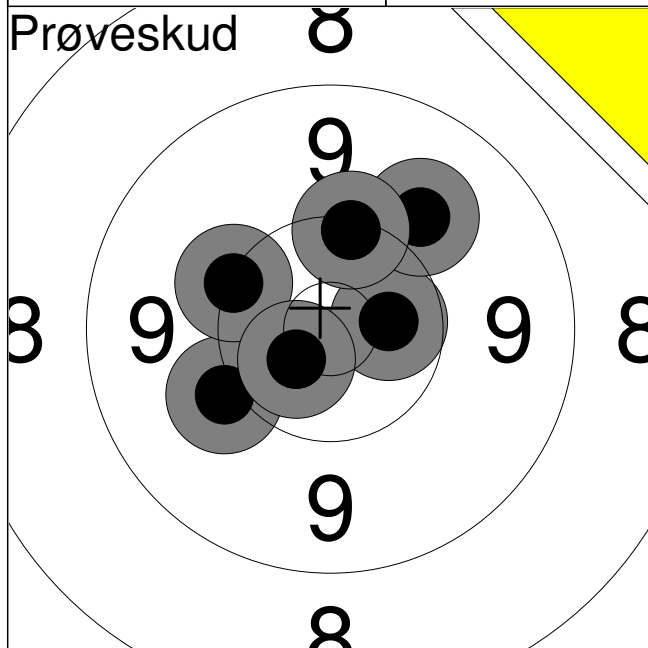

| | | |
|----|-------|---|
| 1: | 10.1 | ↙ |
| 2: | 10.2 | ↖ |
| 3: | *10.5 | → |
| 4: | *10.6 | ↙ |
| 5: | 9.9 | ↗ |
| 6: | 10.2 | ↑ |

| | |
|-------|------|
| Serie | 59.0 |
| Total | 0.0 |

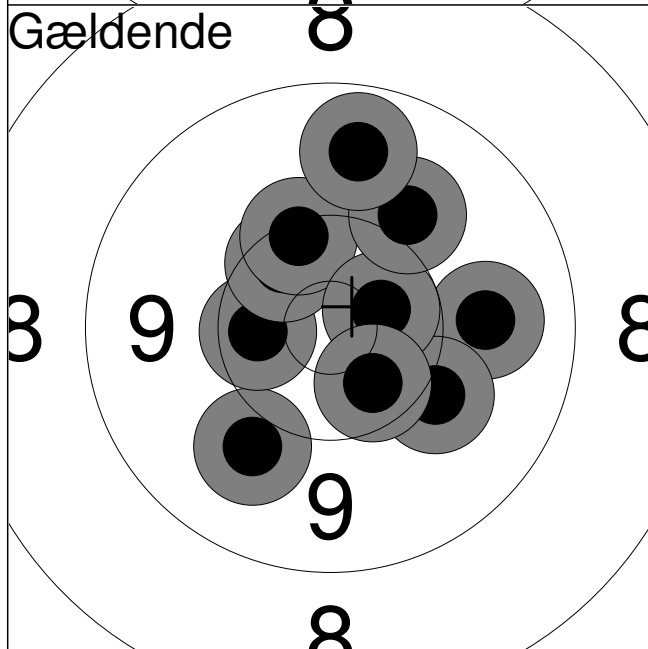

| | | |
|-----|-------|---|
| 1: | 9.9 | → |
| 2: | 10.0 | ↙ |
| 3: | 10.1 | ↘ |
| 4: | *10.4 | ← |
| 5: | 10.4 | ↗ |
| 6: | 10.3 | ↗ |
| 7: | *10.6 | → |
| 8: | 10.0 | ↗ |
| 9: | 9.7 | ↑ |
| 10: | *10.5 | ↘ |

| | |
|-------|------|
| Serie | 98.0 |
| Total | 98.0 |

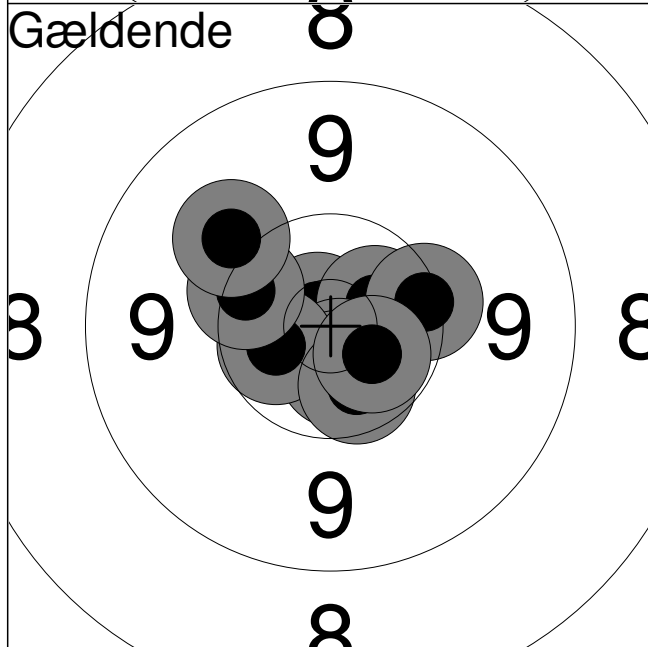

| | | |
|-----|-------|---|
| 11: | *10.8 | ↗ |
| 12: | *10.6 | → |
| 13: | *10.7 | ↘ |
| 14: | *10.6 | ↘ |
| 15: | 10.3 | → |
| 16: | *10.5 | ← |
| 17: | 10.3 | ↗ |
| 18: | 10.0 | ↗ |
| 19: | *10.5 | ↘ |
| 20: | *10.6 | ↘ |

| | |
|-------|-------|
| Serie | 100.0 |
| Total | 198.0 |

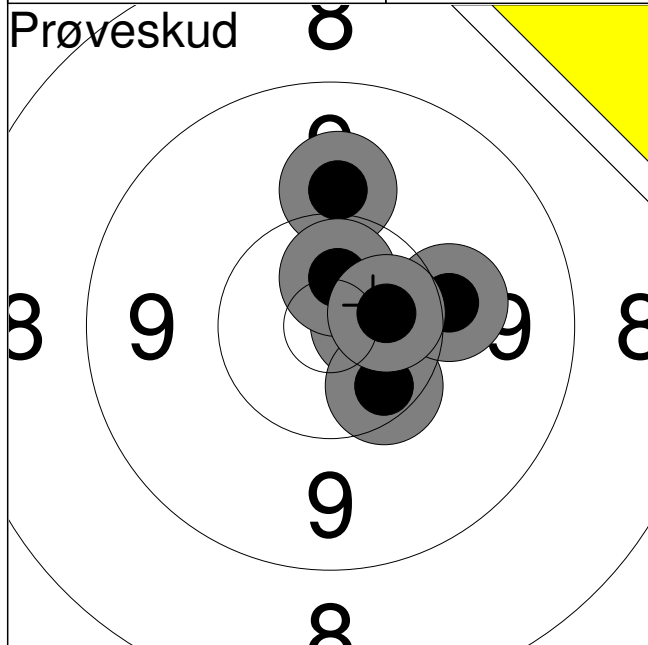

| | | |
|----|-------|---|
| 1: | 10.0 | ↑ |
| 2: | *10.7 | → |
| 3: | 10.4 | ↘ |
| 4: | 10.1 | → |
| 5: | *10.6 | ↑ |
| 6: | *10.5 | → |

| | |
|-------|------|
| Serie | 60.0 |
|-------|------|

| | |
|-------|-----|
| Total | 0.0 |
|-------|-----|

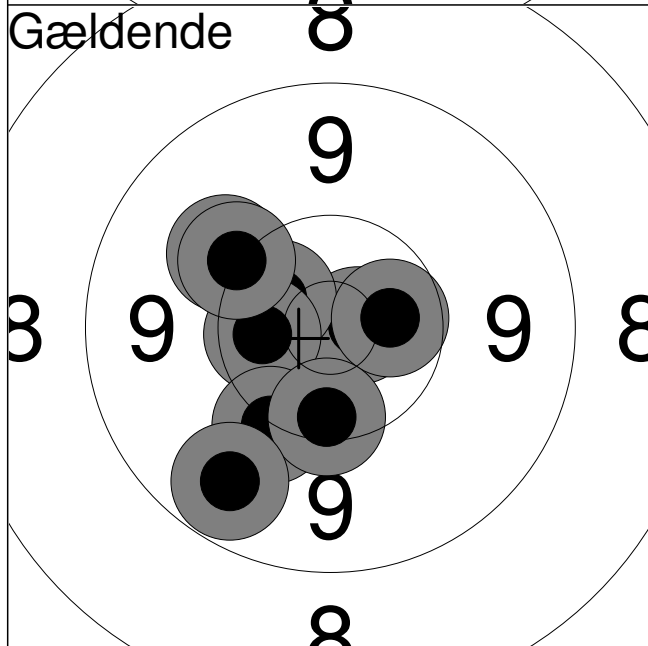

| | | |
|-----|-------|---|
| 1: | *10.8 | ← |
| 2: | *10.8 | → |
| 3: | *10.5 | ↗ |
| 4: | *10.5 | ← |
| 5: | 10.0 | ↗ |
| 6: | *10.5 | → |
| 7: | 10.1 | ↗ |
| 8: | 10.1 | ↘ |
| 9: | 10.3 | ↓ |
| 10: | 9.6 | ↘ |

| | |
|-------|------|
| Serie | 99.0 |
|-------|------|

| | |
|-------|------|
| Total | 99.0 |
|-------|------|

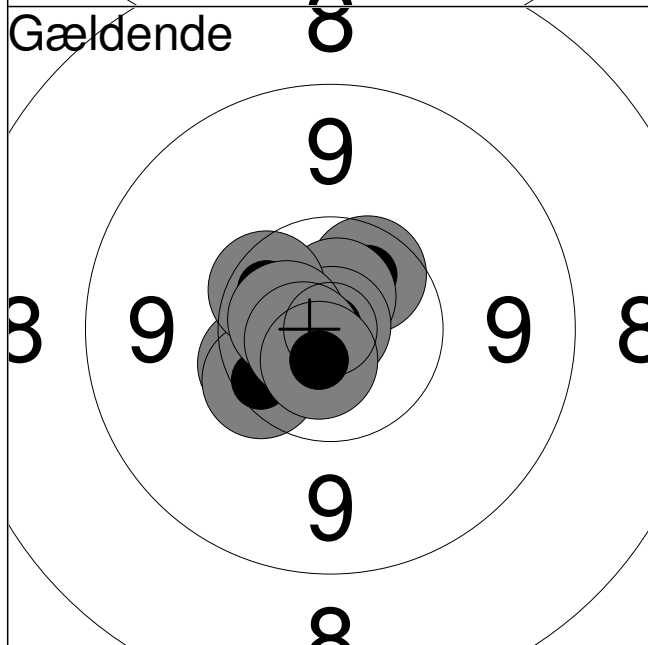

| | | |
|-----|-------|---|
| 11: | *10.5 | ↗ |
| 12: | 10.4 | ← |
| 13: | *10.7 | ↑ |
| 14: | *10.8 | ↘ |
| 15: | 10.3 | ← |
| 16: | *10.9 | ↑ |
| 17: | *10.4 | ↗ |
| 18: | *10.6 | ← |
| 19: | *10.7 | ← |
| 20: | *10.7 | ↘ |

| | |
|-------|-------|
| Serie | 100.0 |
|-------|-------|

| | |
|-------|-------|
| Total | 199.0 |
|-------|-------|

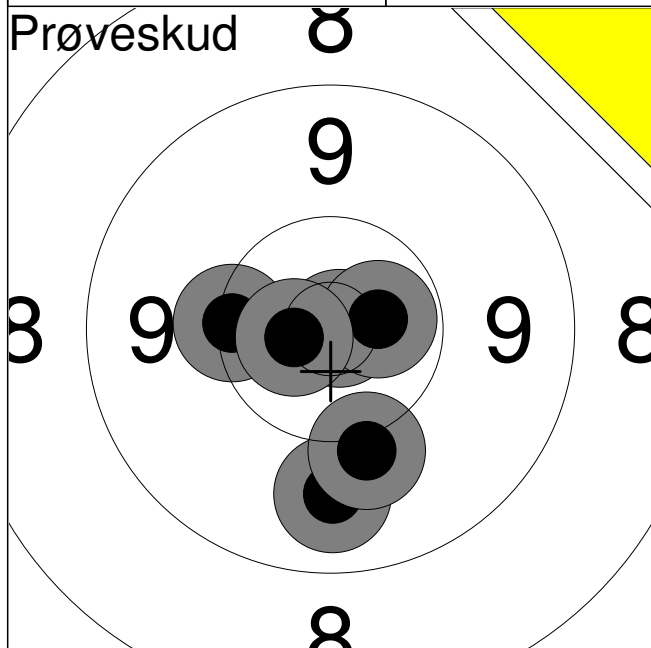

| | | |
|----|-------|---|
| 1: | 9.8 | ↓ |
| 2: | *10.9 | → |
| 3: | 10.3 | ← |
| 4: | *10.6 | → |
| 5: | 10.1 | ↓ |
| 6: | *10.7 | ← |

| | |
|-------|------|
| Serie | 59.0 |
| Total | 0.0 |

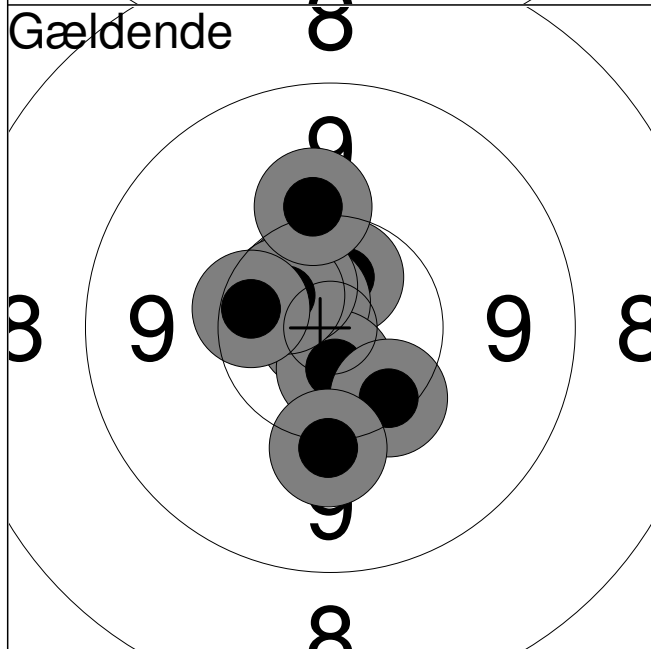

| | | |
|-----|-------|---|
| 1: | *10.9 | ← |
| 2: | *10.6 | ↑ |
| 3: | *10.7 | ↗ |
| 4: | *10.7 | ↓ |
| 5: | 10.3 | ↓ |
| 6: | *10.6 | ↗ |
| 7: | *10.6 | ↗ |
| 8: | 10.1 | ↓ |
| 9: | 10.1 | ↑ |
| 10: | 10.4 | ← |

| | |
|-------|-------|
| Serie | 100.0 |
| Total | 100.0 |

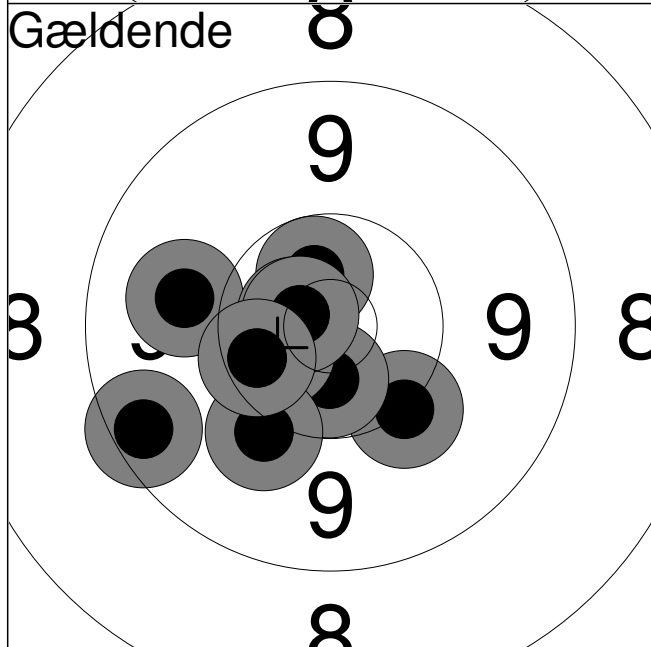

| | | |
|-----|-------|---|
| 11: | 10.2 | ↓ |
| 12: | *10.6 | ↑ |
| 13: | 9.9 | ← |
| 14: | *10.6 | ↓ |
| 15: | *10.7 | ← |
| 16: | *10.5 | ← |
| 17: | 9.4 | ← |
| 18: | 10.1 | ↓ |
| 19: | *10.7 | ← |
| 20: | 10.4 | ← |

| | |
|-------|-------|
| Serie | 98.0 |
| Total | 198.0 |

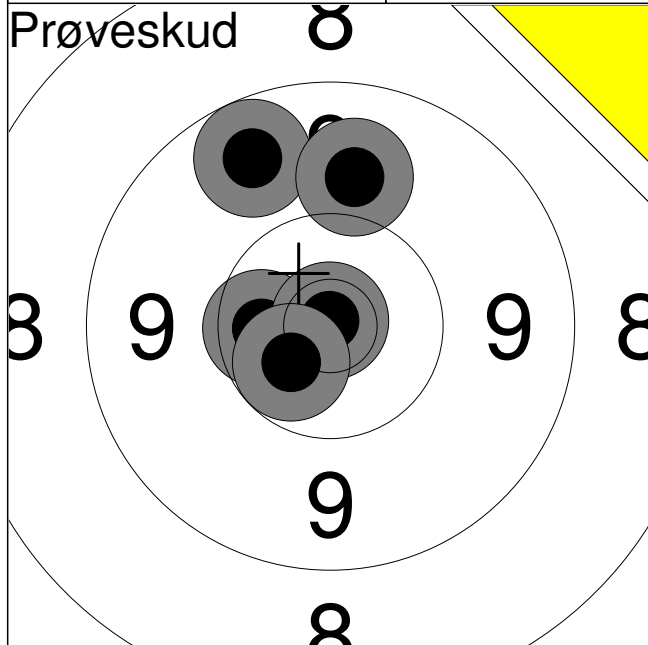

| | | |
|--------------|-------|-------------|
| 1: | 9.6 | ↗ |
| 2: | 9.9 | ↑ |
| 3: | *10.5 | ← |
| 4: | *10.9 | ↑ |
| 5: | *10.6 | ↙ |
| Serie | | 48.0 |
| Total | | 0.0 |

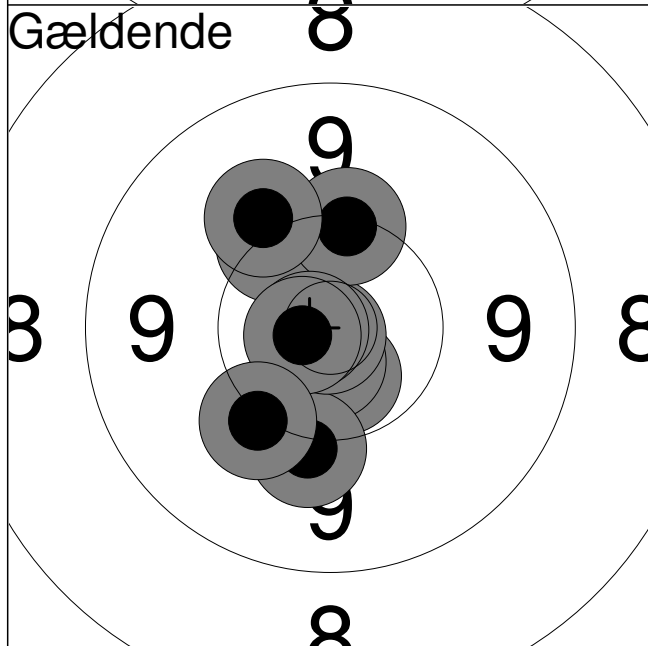

| | | |
|--------------|-------|--------------|
| 1: | *10.6 | ↓ |
| 2: | *10.7 | ↓ |
| 3: | 10.1 | ↓ |
| 4: | *10.9 | ↙ |
| 5: | 10.2 | ↗ |
| 6: | 10.2 | ↑ |
| 7: | *10.8 | ← |
| 8: | *10.7 | ← |
| 9: | 10.0 | ↗ |
| 10: | 10.1 | ↙ |
| Serie | | 100.0 |
| Total | | 100.0 |

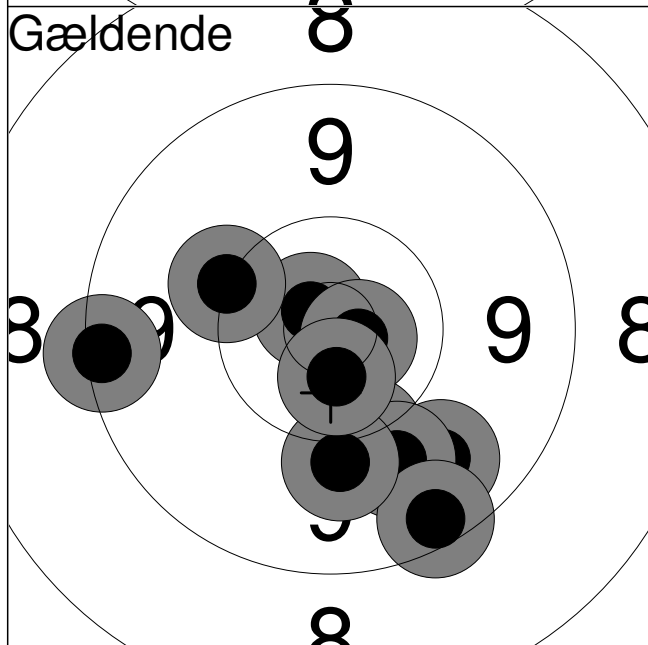

| | | |
|--------------|-------|--------------|
| 11: | *10.8 | ↗ |
| 12: | 9.7 | ↓ |
| 13: | 9.3 | ← |
| 14: | 10.2 | ↗ |
| 15: | 10.2 | ↓ |
| 16: | 9.9 | ↙ |
| 17: | 9.4 | ↙ |
| 18: | *10.7 | → |
| 19: | 10.0 | ↓ |
| 20: | *10.6 | ↓ |
| Serie | | 96.0 |
| Total | | 196.0 |

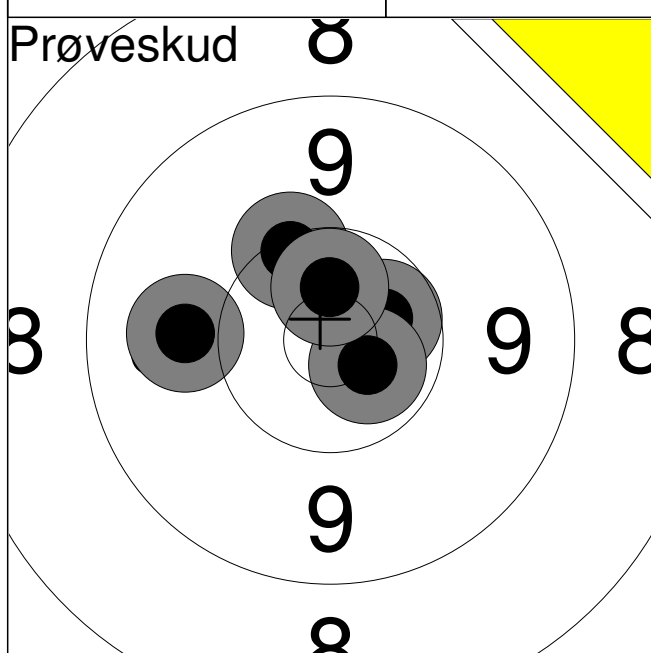

| | | |
|----|-------|---|
| 1: | *10.5 | ↗ |
| 2: | *10.6 | ↘ |
| 3: | 10.3 | ↗ |
| 4: | 9.9 | ← |
| 5: | *10.6 | ↑ |

| | |
|-------|------|
| Serie | 49.0 |
| Total | 0.0 |

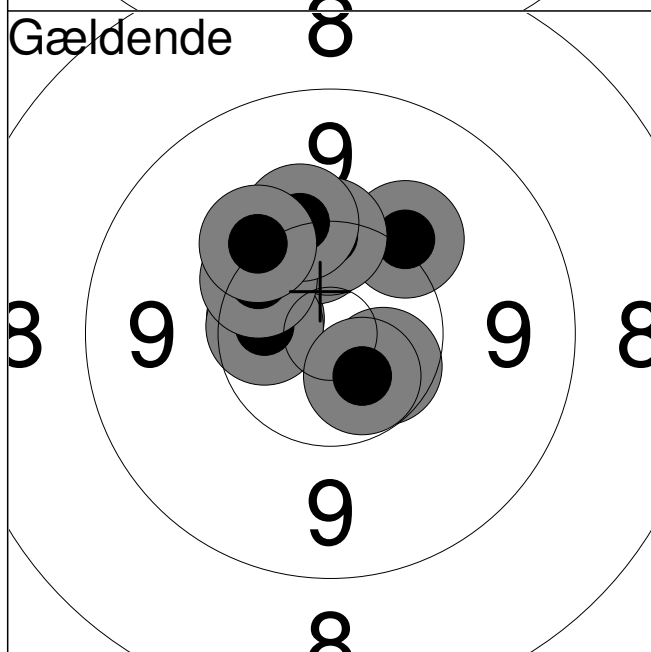

| | | |
|-----|-------|---|
| 1: | *10.5 | ← |
| 2: | *10.5 | ↘ |
| 3: | 10.3 | ↗ |
| 4: | *10.5 | ← |
| 5: | 10.1 | ↗ |
| 6: | 10.3 | ↑ |
| 7: | 10.3 | ↗ |
| 8: | *10.6 | ↘ |
| 9: | 10.1 | ↗ |
| 10: | 10.1 | ↗ |

| | |
|-------|-------|
| Serie | 100.0 |
| Total | 100.0 |

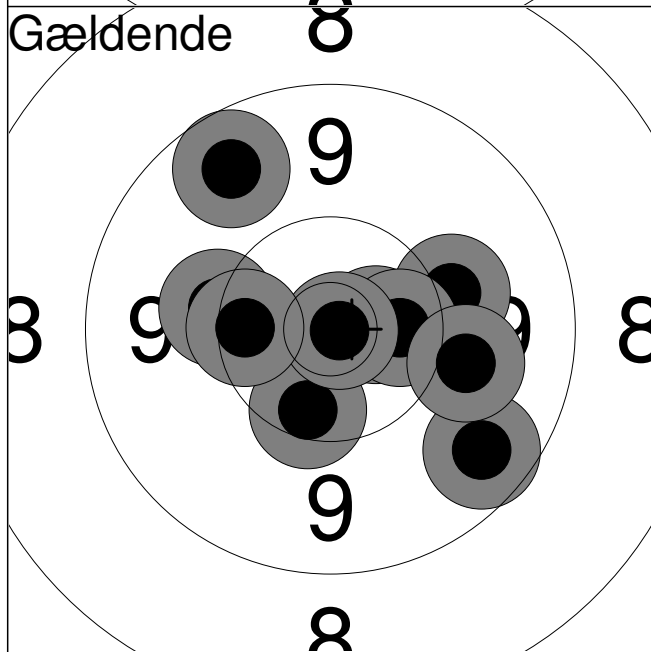

| | | |
|-----|-------|---|
| 11: | 10.1 | ← |
| 12: | 9.6 | ↗ |
| 13: | 10.4 | ↘ |
| 14: | 10.1 | → |
| 15: | 9.6 | ↘ |
| 16: | *10.6 | → |
| 17: | *10.5 | → |
| 18: | 10.0 | ↘ |
| 19: | *10.9 | → |
| 20: | 10.3 | ← |

| | |
|-------|-------|
| Serie | 98.0 |
| Total | 198.0 |

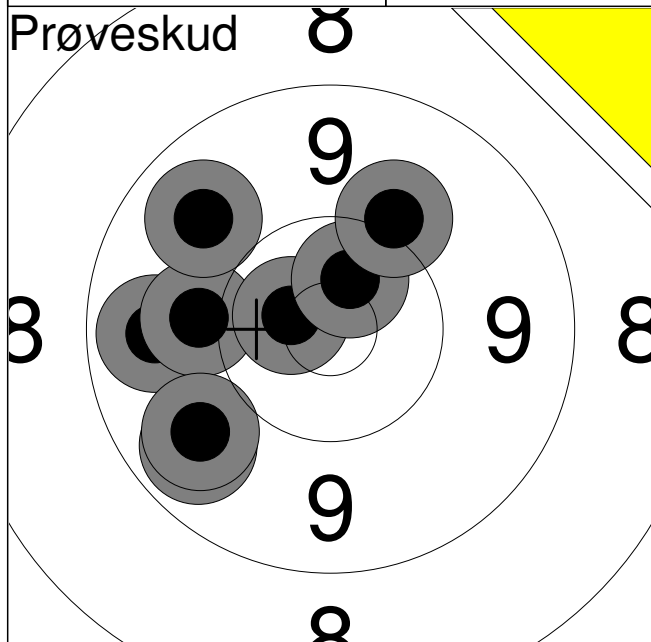

| | | |
|-------|-------|------|
| 1: | 9.7 | ← |
| 2: | 9.7 | ↙ |
| 3: | 10.0 | ← |
| 4: | 9.8 | ↗ |
| 5: | *10.7 | ← |
| 6: | 9.8 | ↙ |
| 7: | *10.6 | ↑ |
| 8: | 10.1 | ↗ |
| Serie | | 76.0 |
| Total | | 0.0 |

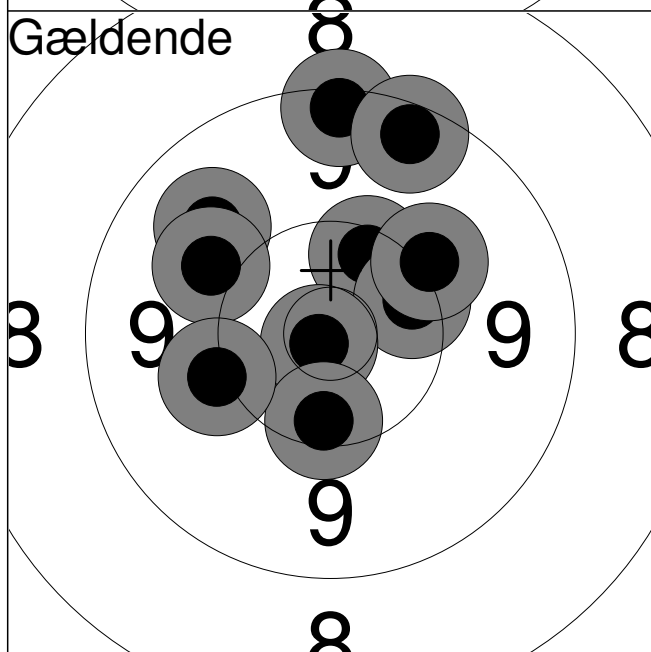

| | | |
|-------|-------|------|
| 1: | 10.3 | ↑ |
| 2: | 9.8 | ↖ |
| 3: | 10.3 | → |
| 4: | 9.3 | ↑ |
| 5: | *10.8 | ↙ |
| 6: | 10.1 | ↗ |
| 7: | 10.3 | ↓ |
| 8: | 10.0 | ↖ |
| 9: | 10.1 | ← |
| 10: | 9.4 | ↑ |
| Serie | | 97.0 |
| Total | | 97.0 |

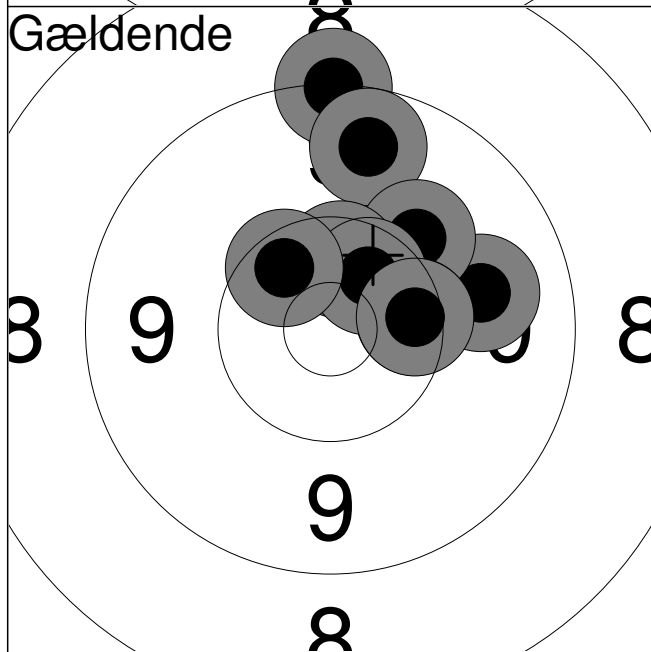

| | | |
|-------|-------|-------|
| 11: | 9.2 | ↑ |
| 12: | 9.9 | → |
| 13: | 9.6 | ↑ |
| 14: | 10.4 | ↗ |
| 15: | 10.1 | ↗ |
| 16: | *10.5 | ↑ |
| 17: | 10.4 | → |
| 18: | *10.5 | ↗ |
| 19: | *10.4 | ↖ |
| 20: | 10.3 | → |
| Serie | | 97.0 |
| Total | | 194.0 |

| | | | |
|------|-------|-------------------|--|
| Hold | Skive | Nikoline Svendsen | |
| 19 | 5 | | |

| | | |
|-----|---------------------|-----|
| 50m | Vester Hassing Skf. | MJ2 |
|-----|---------------------|-----|

| | | |
|---------------|------------------|---------------------|
| 29/5-2/6 2013 | Jeppestævne 2013 | Aalborg Skyttekreds |
|---------------|------------------|---------------------|

| | |
|--------------------------------|--------------------------------|
| Ant. obligatoriske træningskud | Arrangørlagets navn og stempel |
|--------------------------------|--------------------------------|

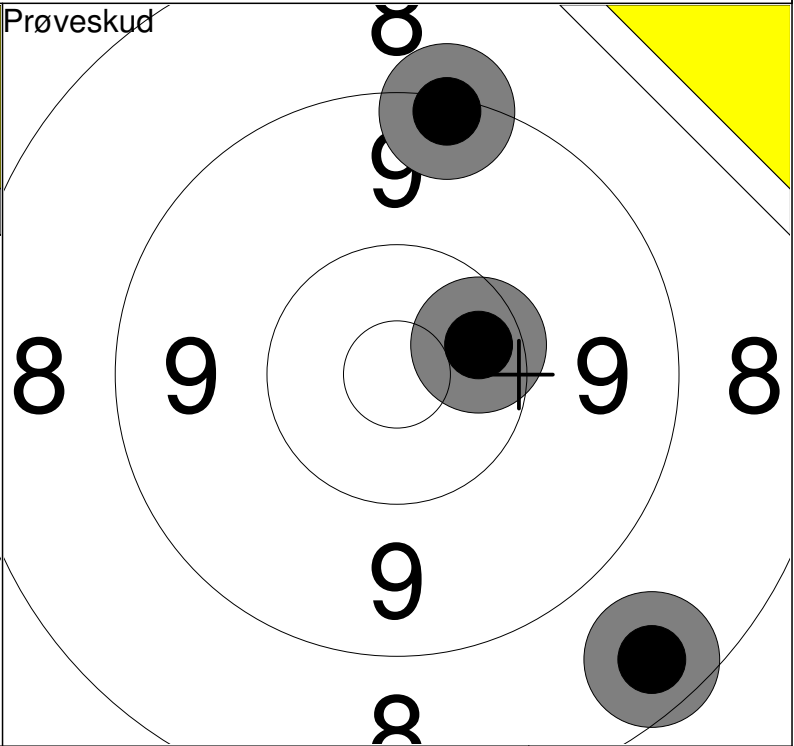
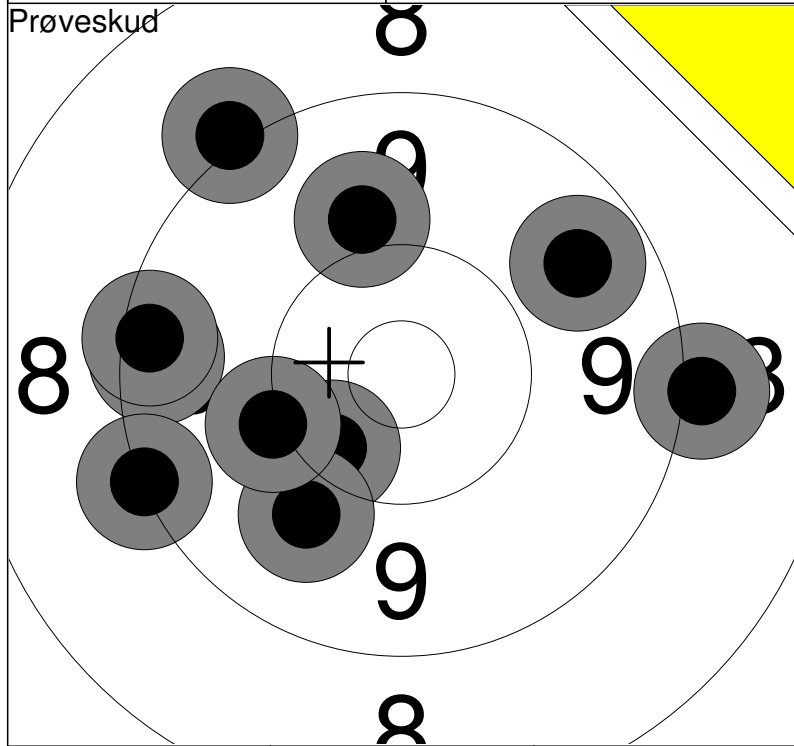

| | | | |
|-----------|-----------|-------|----|
| 1: 9.4 ← | 6: 10.0 ↑ | Serie | 93 |
| 2: 9.4 ← | 7: 9.1 ↗ | | |
| 3: 9.2 ↙ | 8: 10.1 ← | Total | 0 |
| 4: 10.3 ↘ | 9: 9.1 → | | |
| 5: 9.9 ↘ | 10: 9.7 ↗ | | |

| | | |
|-------------|-------|----|
| 11: 9.3 ↑ | Serie | 27 |
| 12: *10.4 → | | |
| 13: 8.5 ↘ | Total | 0 |

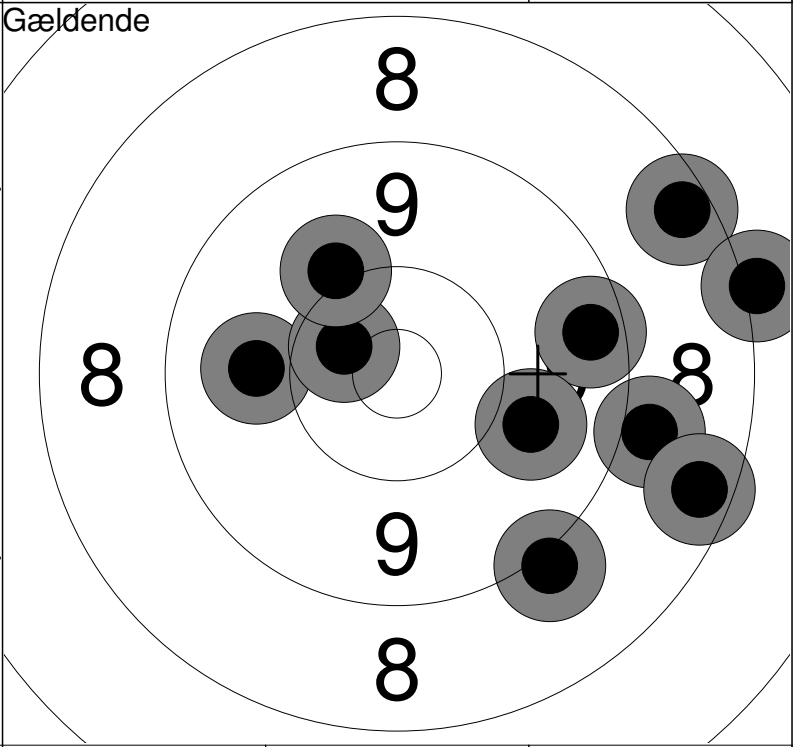
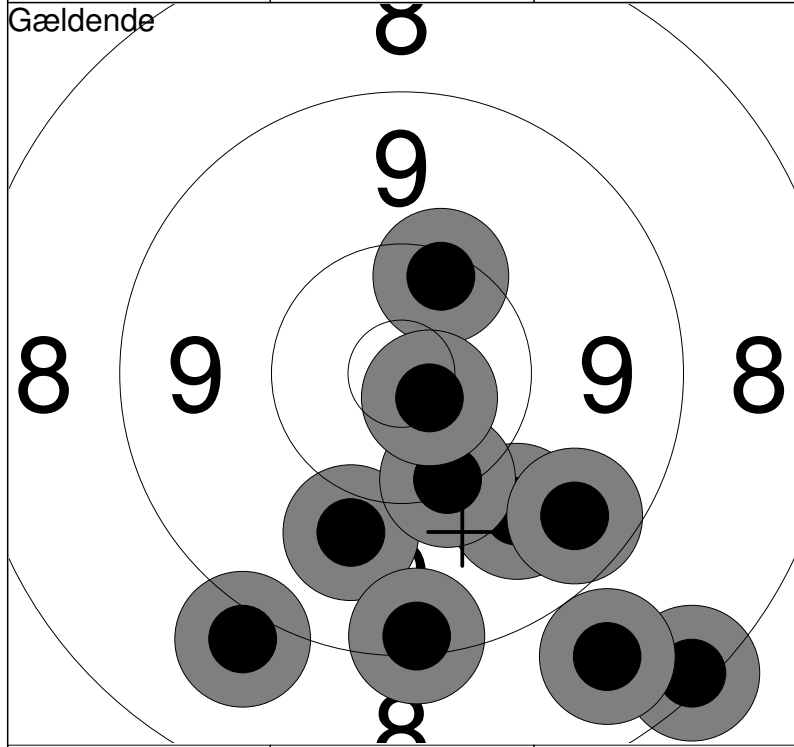

| | | | |
|-----------|------------|-------|----|
| 1: 9.8 ↘ | 6: 8.7 ↘ | Serie | 91 |
| 2: 9.0 ↘ | 7: 10.2 ↘ | | |
| 3: 10.3 ↑ | 8: 9.3 ↘ | Total | 91 |
| 4: 9.9 ↘ | 9: *10.7 ↘ | | |
| 5: 8.3 ↘ | 10: 9.6 ↘ | | |

| | | | |
|-------------|------------|-------|-----|
| 11: 9.9 ← | 16: 8.4 → | Serie | 89 |
| 12: *10.5 ↖ | 17: 9.1 ↘ | | |
| 13: 9.0 → | 18: 9.9 → | Total | 180 |
| 14: 8.4 → | 19: 10.1 ↗ | | |
| 15: 9.4 → | 20: 8.1 → | | |

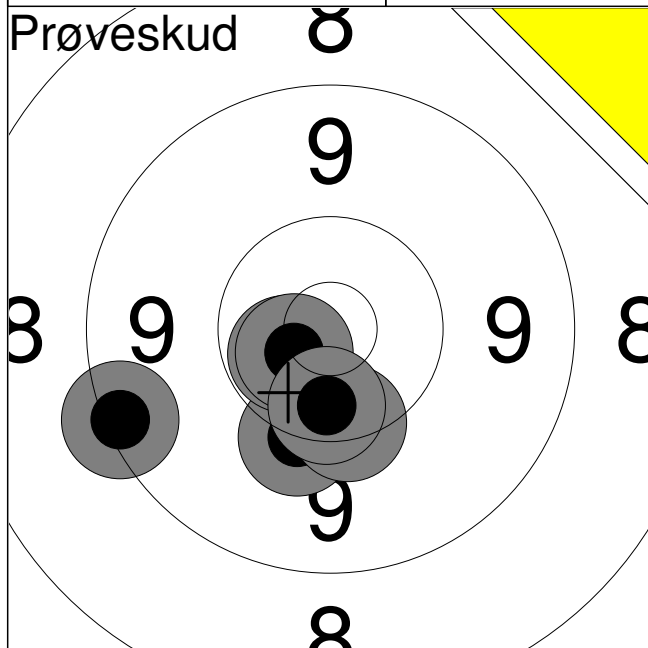

| | | |
|--------------|-------|-------------|
| 1: | 9.3 | ↙ |
| 2: | 10.2 | ↓ |
| 3: | *10.6 | ↙ |
| 4: | 10.3 | ↓ |
| 5: | *10.6 | ↙ |
| 6: | 10.4 | ↓ |
| Serie | | 59.0 |
| Total | | 0.0 |

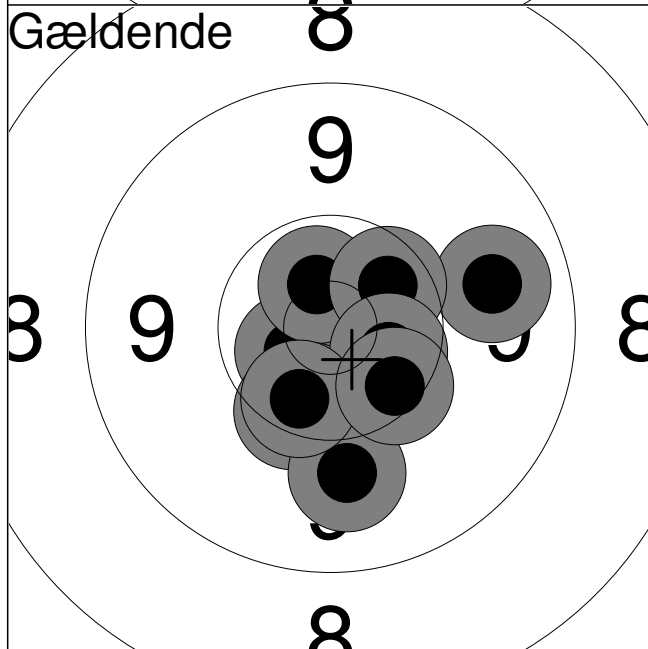

| | | |
|--------------|-------|-------------|
| 1: | 9.8 | → |
| 2: | *10.6 | ↙ |
| 3: | *10.6 | ↑ |
| 4: | *10.4 | ↓ |
| 5: | *10.5 | ↗ |
| 6: | 10.3 | ↓ |
| 7: | 9.9 | ↓ |
| 8: | *10.5 | → |
| 9: | 10.4 | ↓ |
| 10: | 10.3 | ↘ |
| Serie | | 98.0 |
| Total | | 98.0 |

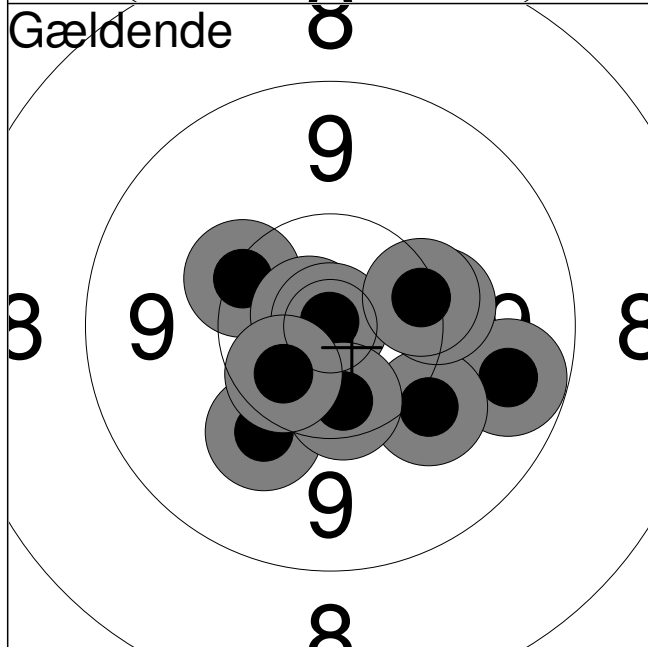

| | | |
|--------------|-------|--------------|
| 11: | 10.2 | ↗ |
| 12: | 10.1 | ↙ |
| 13: | *10.8 | ↗ |
| 14: | *10.9 | ↑ |
| 15: | 9.6 | → |
| 16: | 10.1 | ↓ |
| 17: | 10.2 | → |
| 18: | *10.4 | ↓ |
| 19: | 10.3 | → |
| 20: | *10.5 | ↙ |
| Serie | | 99.0 |
| Total | | 197.0 |

| | | | |
|------|-------|---------------|--|
| Hold | Skive | Lars Jakobsen | |
| 19 | 8 | | |

| | | |
|-----|--------------|-----|
| 50m | Vilsted Skf. | ÅK1 |
|-----|--------------|-----|

| | | |
|---------------|------------------|---------------------|
| 29/5-2/6 2013 | Jeppestævne 2013 | Aalborg Skyttekreds |
|---------------|------------------|---------------------|

| | |
|--------------------------------|--------------------------------|
| Ant. obligatoriske træningskud | Arrangørlagets navn og stempel |
|--------------------------------|--------------------------------|

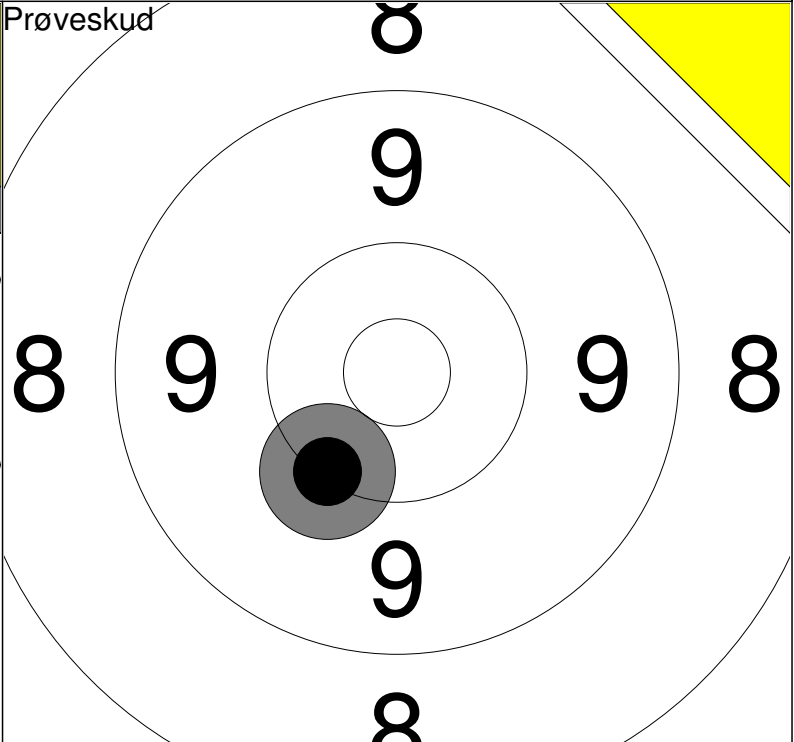
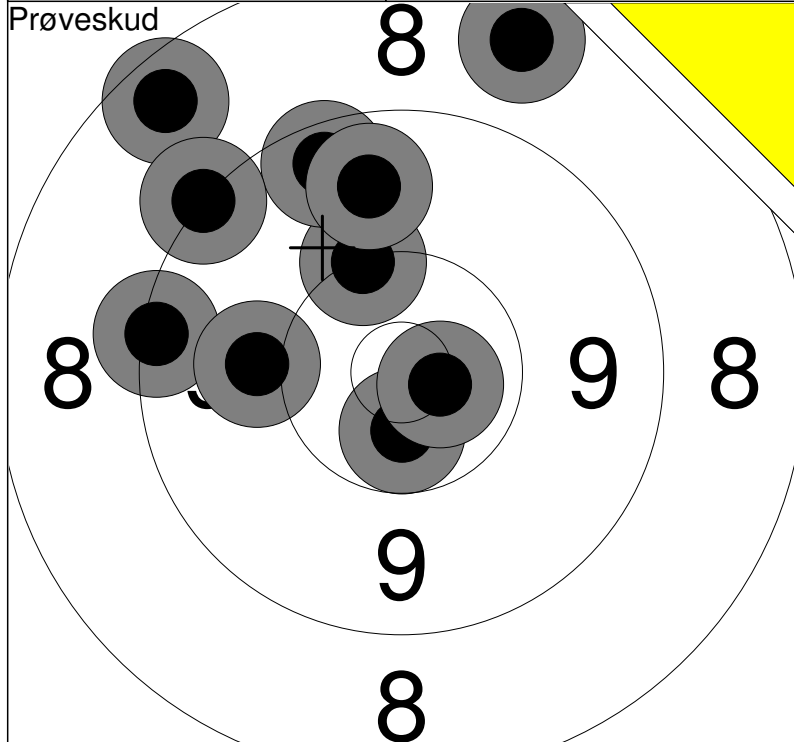

| | | | |
|------------|-----------|-------|----|
| 1: 8.5 ↗ | 6: 10.2 ↗ | Serie | 92 |
| 2: *10.6 ↓ | 7: 9.5 ↗ | | |
| 3: 9.3 ← | 8: 10.0 ← | Total | 0 |
| 4: *10.7 → | 9: 9.7 ↗ | | |
| 5: 8.5 ↗ | 10: 9.2 ↗ | | |

| | | |
|------------|-------|----|
| 11: 10.2 ↓ | Serie | 10 |
| | | |
| | Total | 0 |
| | | |

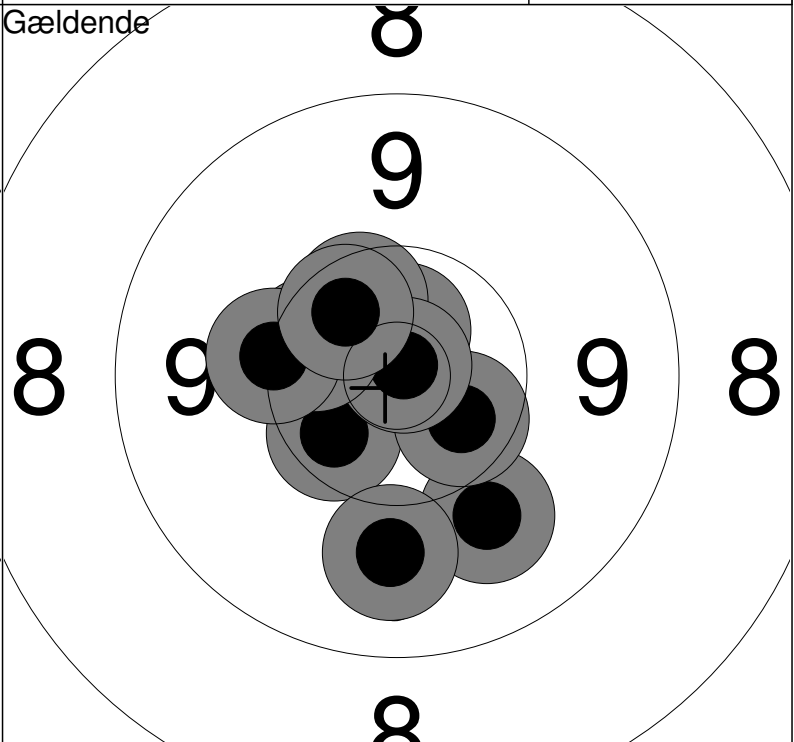
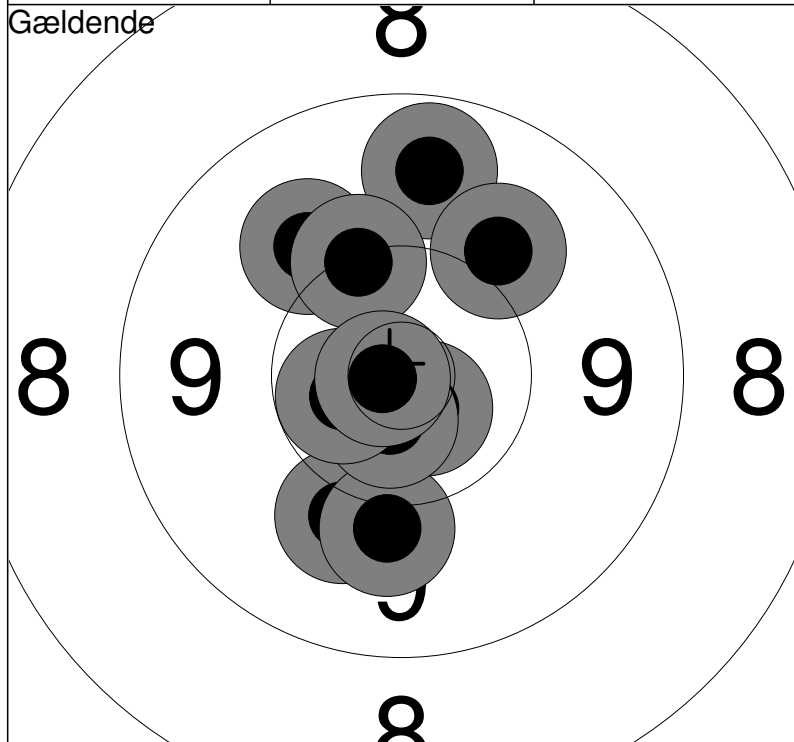

| | | | |
|------------|-------------|-------|----|
| 1: 10.0 ↓ | 6: 10.0 ↗ | Serie | 99 |
| 2: 10.0 ↓ | 7: 9.7 ↗ | | |
| 3: *10.7 ↓ | 8: 10.0 ↗ | Total | 99 |
| 4: *10.7 ↓ | 9: 10.2 ↗ | | |
| 5: *10.6 ← | 10: *10.8 ← | | |

| | | | |
|-------------|-------------|-------|-----|
| 11: 9.9 ↓ | 16: *10.9 ↗ | Serie | 98 |
| 12: *10.7 ↗ | 17: *10.4 ← | | |
| 13: *10.4 ↓ | 18: 10.2 ← | Total | 197 |
| 14: *10.5 → | 19: *10.5 ↗ | | |
| 15: *10.4 ↗ | 20: 9.9 ↓ | | |

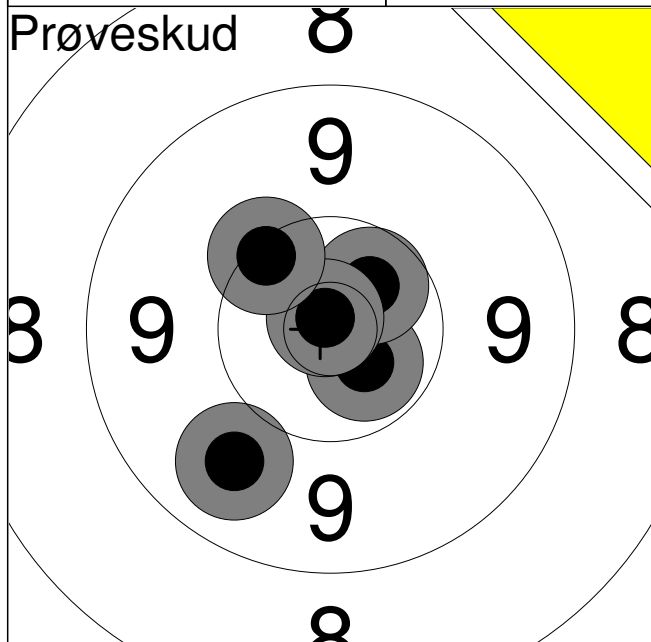

| | | |
|--------------|-------|-------------|
| 1: | 9.8 | ↙ |
| 2: | *10.6 | ↘ |
| 3: | *10.5 | ↗ |
| 4: | *10.9 | ↗ |
| 5: | 10.3 | ↗ |
| Serie | | 49.0 |
| Total | | 0.0 |

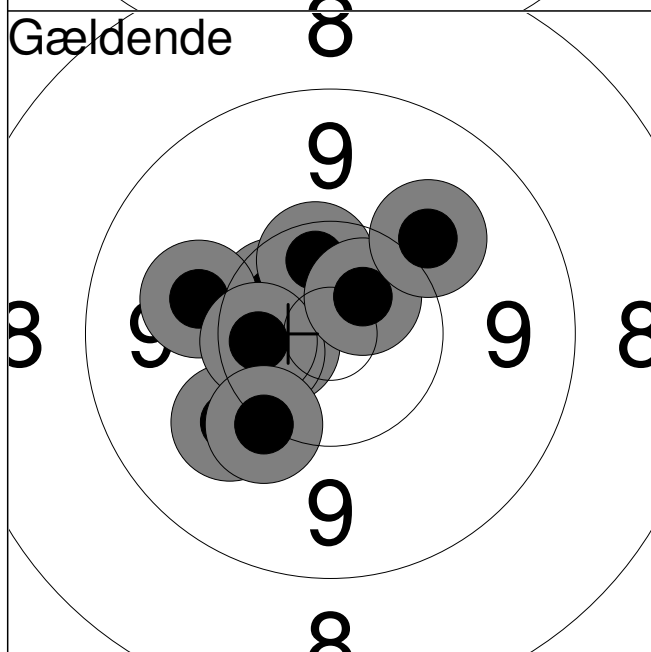

| | | |
|--------------|-------|--------------|
| 1: | *10.6 | ← |
| 2: | *10.5 | ↗ |
| 3: | 10.0 | ← |
| 4: | *10.4 | ↗ |
| 5: | *10.5 | ← |
| 6: | 10.0 | ↙ |
| 7: | *10.4 | ← |
| 8: | *10.6 | ↗ |
| 9: | 10.2 | ↙ |
| 10: | 10.0 | ↗ |
| Serie | | 100.0 |
| Total | | 100.0 |

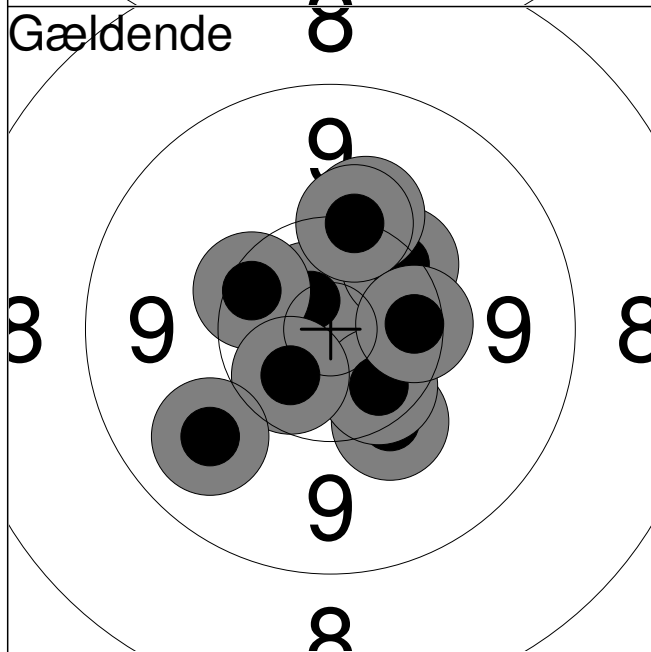

| | | |
|--------------|-------|--------------|
| 11: | *10.7 | ↗ |
| 12: | 10.3 | ↗ |
| 13: | 10.3 | ↗ |
| 14: | 10.2 | ↙ |
| 15: | *10.4 | ↙ |
| 16: | 10.1 | ↗ |
| 17: | *10.5 | ↙ |
| 18: | 9.8 | ↙ |
| 19: | 10.2 | ↗ |
| 20: | 10.4 | → |
| Serie | | 99.0 |
| Total | | 199.0 |

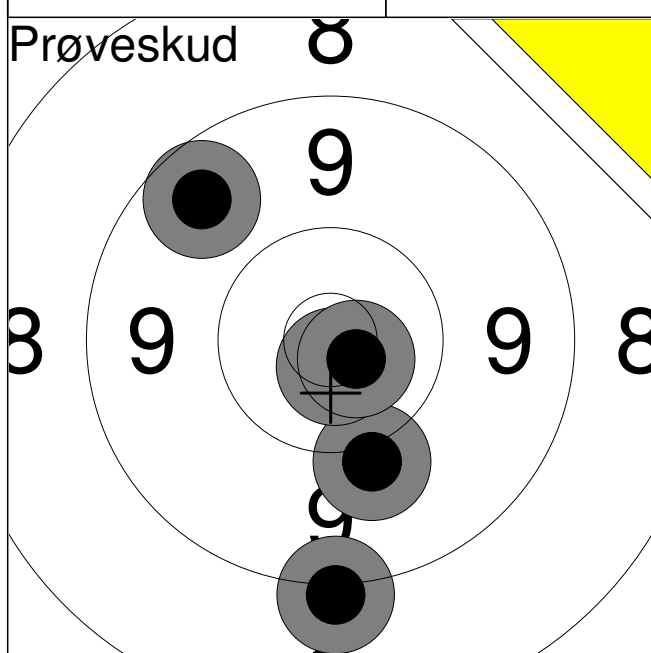

| | | |
|----|-------|---|
| 1: | 9.1 | ↓ |
| 2: | 10.0 | ↓ |
| 3: | 9.6 | ↗ |
| 4: | *10.8 | ↓ |
| 5: | *10.7 | ↓ |

| | |
|-------|------|
| Serie | 48.0 |
| Total | 0.0 |

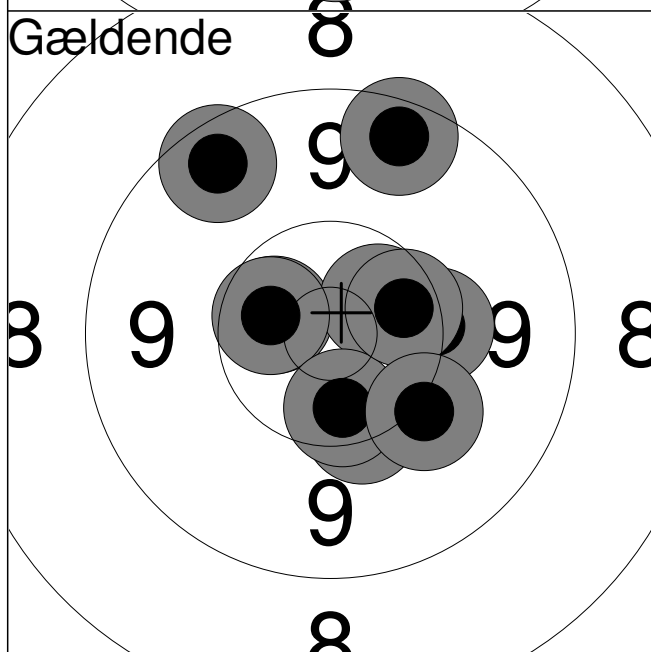

| | | |
|-----|-------|---|
| 1: | *10.5 | ↖ |
| 2: | 10.2 | → |
| 3: | 10.3 | ↓ |
| 4: | *10.5 | ↗ |
| 5: | *10.5 | ↖ |
| 6: | *10.4 | ↓ |
| 7: | 10.4 | → |
| 8: | 9.4 | ↗ |
| 9: | 9.5 | ↗ |
| 10: | 10.1 | ↓ |

| | |
|-------|------|
| Serie | 98.0 |
| Total | 98.0 |

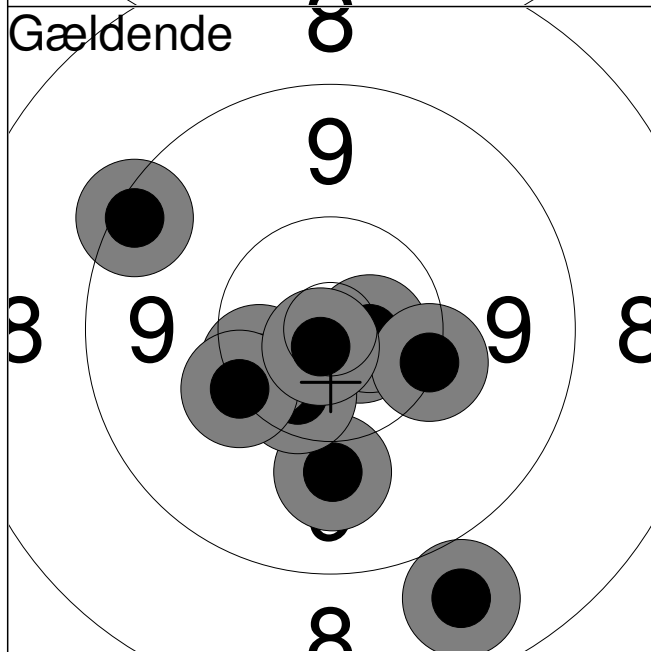

| | | |
|-----|-------|---|
| 11: | 9.3 | ↗ |
| 12: | 8.8 | ↓ |
| 13: | 9.9 | ↓ |
| 14: | *10.7 | ↓ |
| 15: | *10.4 | ↓ |
| 16: | *10.7 | → |
| 17: | 10.2 | → |
| 18: | 10.4 | ↖ |
| 19: | 10.2 | ↖ |
| 20: | *10.8 | ↓ |

| | |
|-------|-------|
| Serie | 96.0 |
| Total | 194.0 |

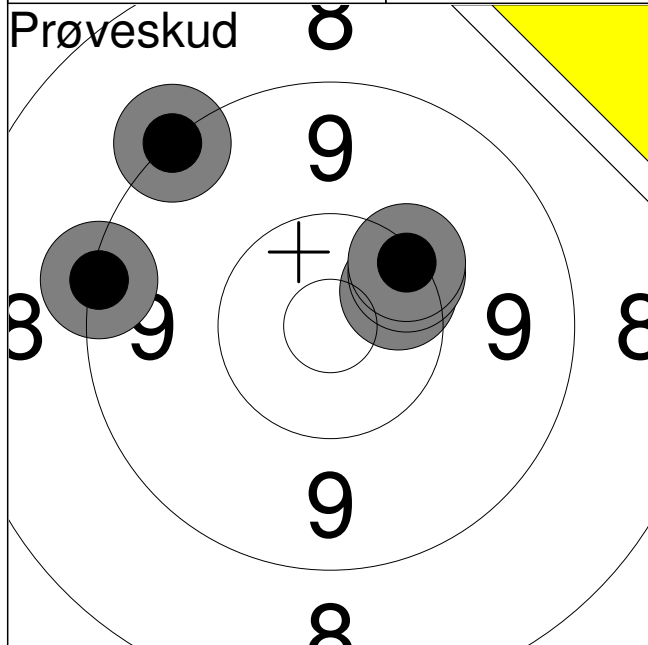

| | | |
|----|-------|---|
| 1: | 9.2 | ← |
| 2: | 9.2 | ↗ |
| 3: | *10.4 | → |
| 4: | 10.3 | ↗ |
| 5: | 10.3 | ↗ |

| | |
|-------|------|
| Serie | 48.0 |
| Total | 0.0 |

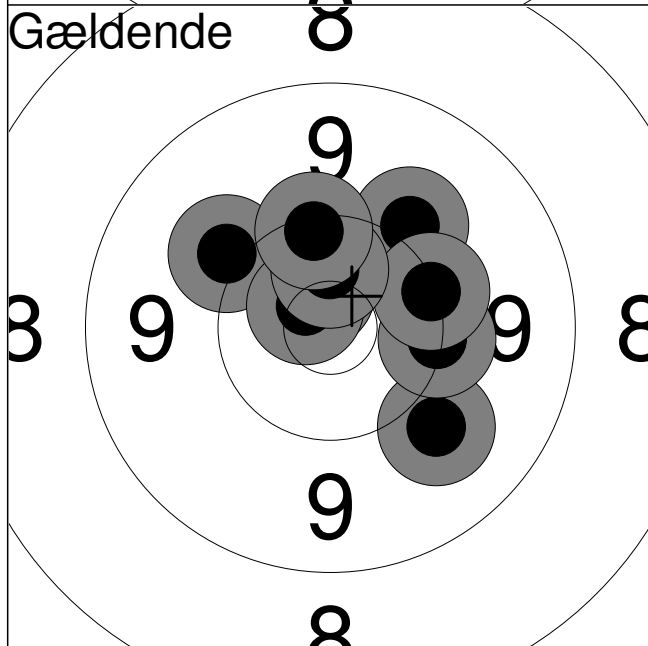

| | | |
|-----|-------|---|
| 1: | 10.1 | ↖ |
| 2: | 10.0 | ↗ |
| 3: | 9.9 | ↘ |
| 4: | *10.7 | ↗ |
| 5: | 10.2 | → |
| 6: | *10.5 | ↑ |
| 7: | 10.2 | → |
| 8: | *10.7 | ↗ |
| 9: | *10.5 | ↑ |
| 10: | 10.3 | ↑ |

| | |
|-------|------|
| Serie | 99.0 |
| Total | 99.0 |

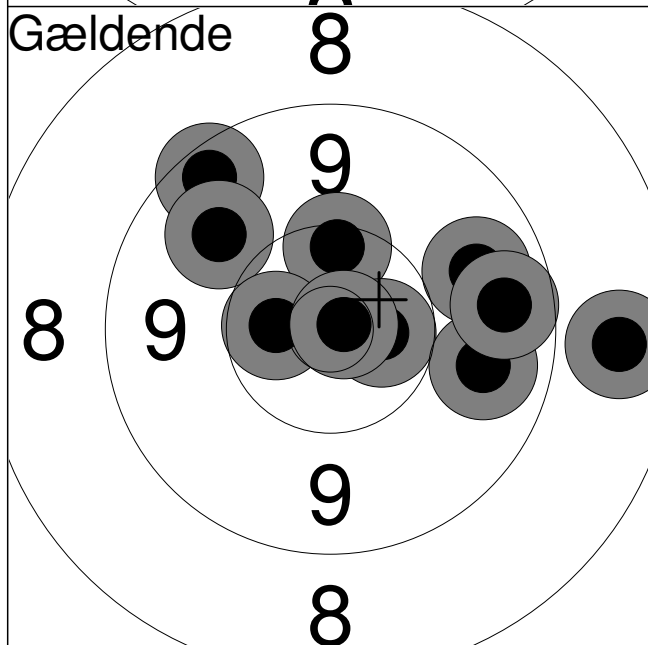

| | | |
|-----|-------|---|
| 11: | 9.4 | ↗ |
| 12: | 9.7 | → |
| 13: | 10.3 | ↑ |
| 14: | 9.8 | ↗ |
| 15: | 8.6 | → |
| 16: | *10.6 | → |
| 17: | 9.7 | ↘ |
| 18: | 9.6 | → |
| 19: | *10.5 | ← |
| 20: | *10.8 | → |

| | |
|-------|-------|
| Serie | 93.0 |
| Total | 192.0 |



| | | |
|----|-------|---|
| 1: | 10.4 | ↗ |
| 2: | *10.4 | ↖ |
| 3: | 9.3 | ← |
| 4: | 10.3 | ← |
| 5: | *10.8 | ↗ |

| | |
|-------|------|
| Serie | 49.0 |
| Total | 0.0 |

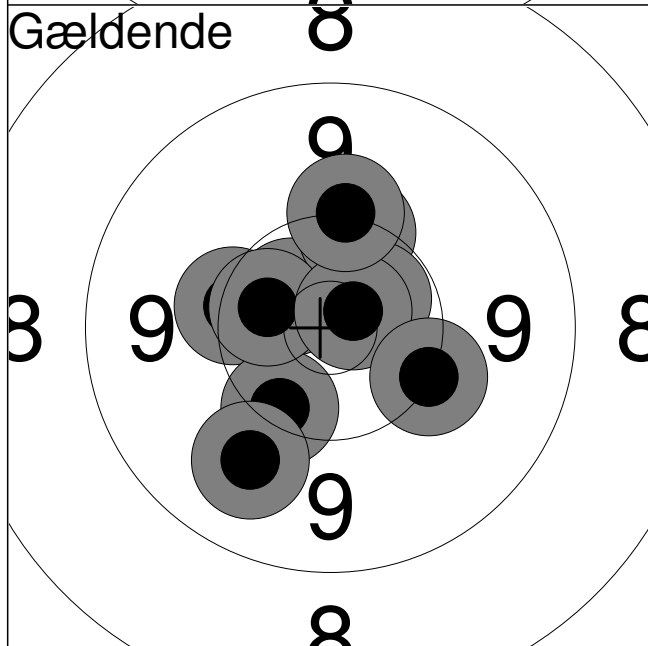

| | | |
|-----|-------|---|
| 1: | *10.6 | ↗ |
| 2: | 10.2 | ↖ |
| 3: | 10.3 | ↙ |
| 4: | 10.3 | ↑ |
| 5: | *10.6 | ↗ |
| 6: | *10.5 | ↖ |
| 7: | 9.9 | ↙ |
| 8: | *10.8 | ↗ |
| 9: | 10.2 | → |
| 10: | 10.1 | ↑ |

| | |
|-------|------|
| Serie | 99.0 |
| Total | 99.0 |

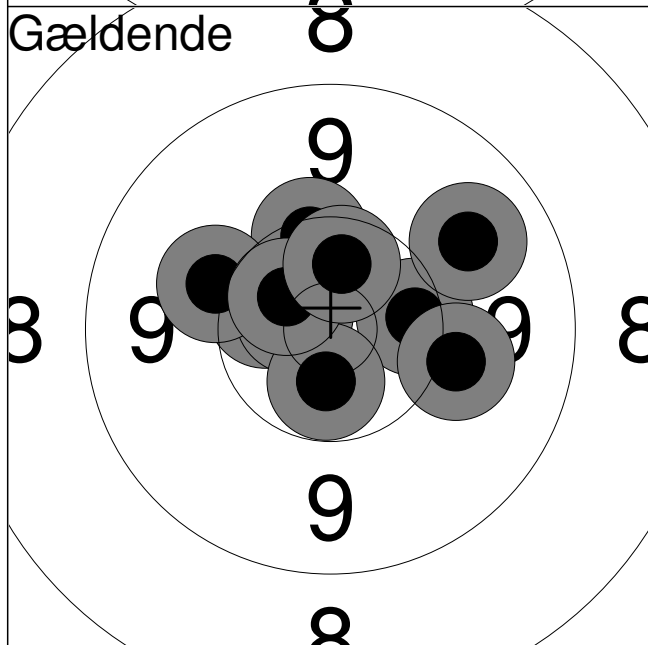

| | | |
|-----|-------|---|
| 11: | 10.3 | ↑ |
| 12: | *10.5 | ↖ |
| 13: | 10.3 | → |
| 14: | *10.7 | ↖ |
| 15: | *10.6 | ↙ |
| 16: | 9.8 | ↗ |
| 17: | 10.0 | → |
| 18: | 10.1 | ↖ |
| 19: | *10.6 | ↗ |
| 20: | *10.5 | ↑ |

| | |
|-------|-------|
| Serie | 99.0 |
| Total | 198.0 |

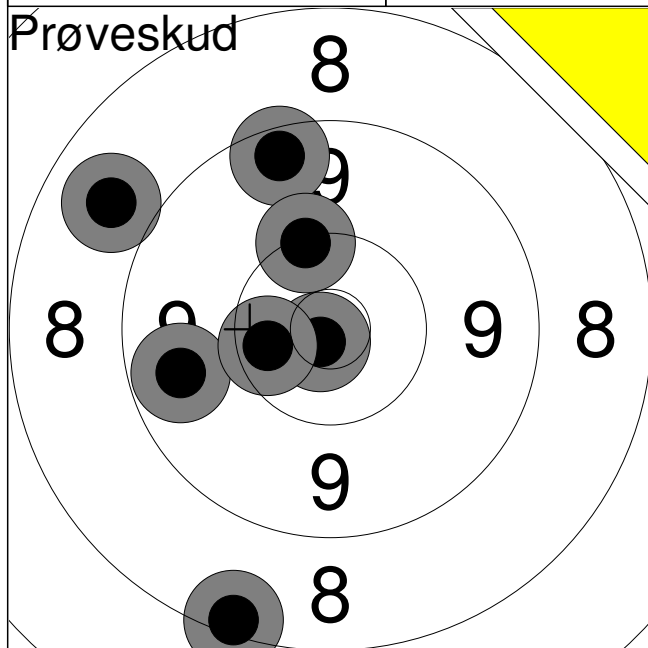

| | | |
|----|-------|---|
| 1: | 8.3 | ↘ |
| 2: | 9.6 | ← |
| 3: | 8.8 | ↗ |
| 4: | 9.4 | ↗ |
| 5: | 10.2 | ↗ |
| 6: | *10.8 | ↘ |
| 7: | *10.4 | ← |

| | |
|-------|------|
| Serie | 64.0 |
| Total | 0.0 |

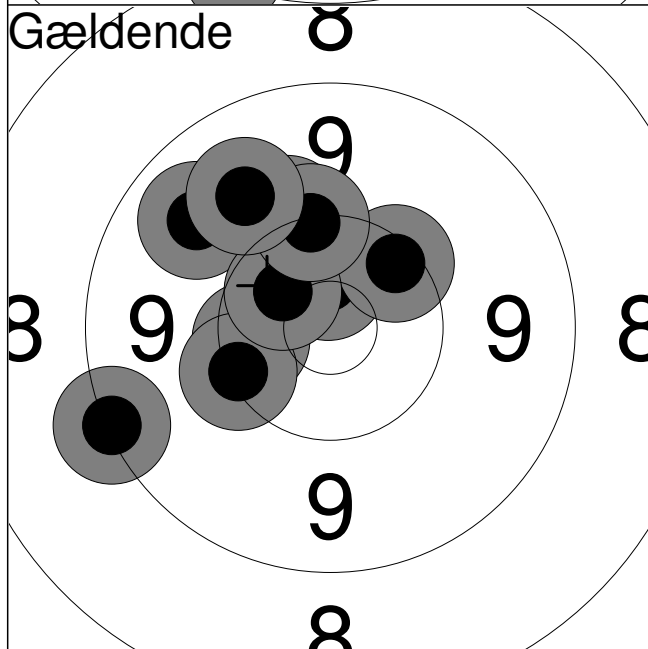

| | | |
|-----|-------|---|
| 1: | *10.6 | ↑ |
| 2: | 10.4 | ← |
| 3: | 10.3 | ↗ |
| 4: | 10.1 | ↗ |
| 5: | 10.2 | ← |
| 6: | 9.7 | ↗ |
| 7: | *10.5 | ↗ |
| 8: | 10.2 | ↗ |
| 9: | 9.8 | ↗ |
| 10: | 9.2 | ← |

| | |
|-------|------|
| Serie | 97.0 |
| Total | 97.0 |

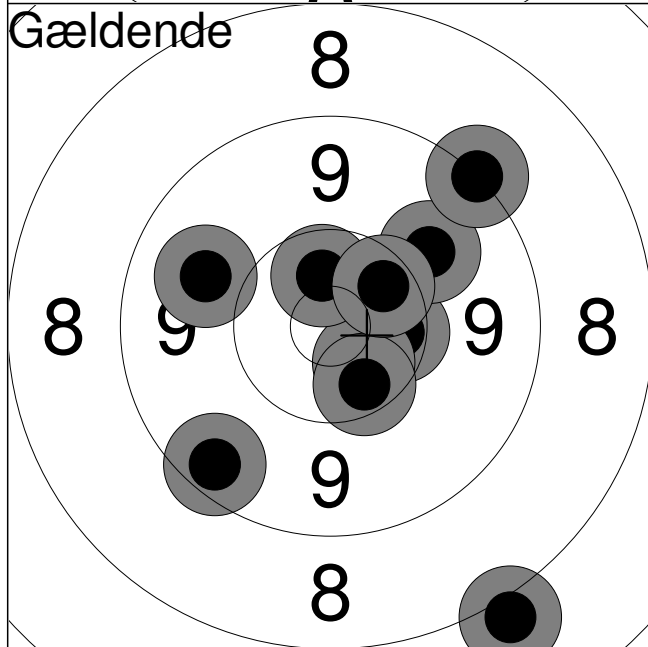

| | | |
|-----|-------|---|
| 11: | 10.4 | → |
| 12: | *10.5 | ↘ |
| 13: | 8.0 | ↘ |
| 14: | 10.4 | ↘ |
| 15: | 9.9 | ↗ |
| 16: | *10.5 | ↗ |
| 17: | 9.2 | ↗ |
| 18: | 10.4 | ↗ |
| 19: | 9.8 | ← |
| 20: | 9.4 | ↘ |

| | |
|-------|-------|
| Serie | 94.0 |
| Total | 191.0 |

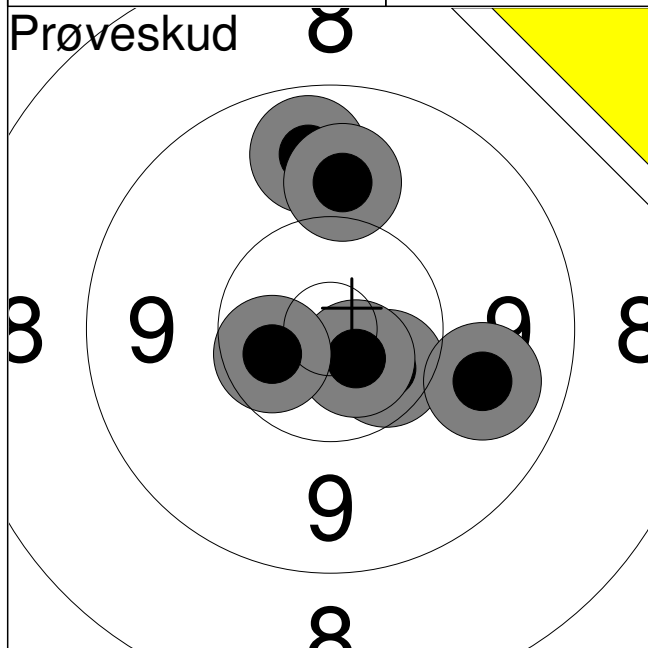

| | | |
|----|-------|---|
| 1: | 9.7 | ↑ |
| 2: | 9.9 | ↑ |
| 3: | *10.5 | ↓ |
| 4: | 9.8 | ↓ |
| 5: | *10.7 | ↓ |
| 6: | *10.5 | ← |

| | |
|-------|------|
| Serie | 57.0 |
|-------|------|

| | |
|-------|-----|
| Total | 0.0 |
|-------|-----|

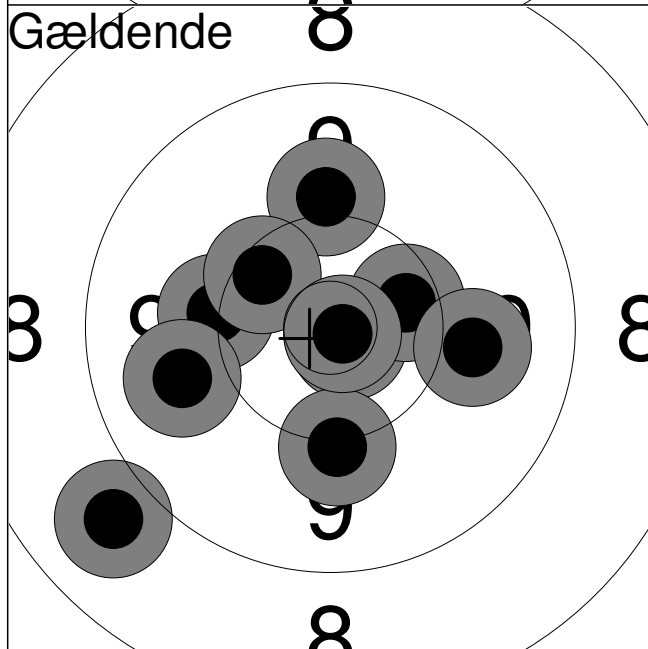

| | | |
|-----|-------|---|
| 1: | *10.8 | ↓ |
| 2: | 10.0 | ↑ |
| 3: | 10.1 | ↓ |
| 4: | 8.8 | ↙ |
| 5: | 10.4 | → |
| 6: | 9.9 | → |
| 7: | 10.1 | ← |
| 8: | 9.8 | ← |
| 9: | 10.3 | ↗ |
| 10: | *10.9 | ↓ |

| | |
|-------|------|
| Serie | 96.0 |
|-------|------|

| | |
|-------|------|
| Total | 96.0 |
|-------|------|

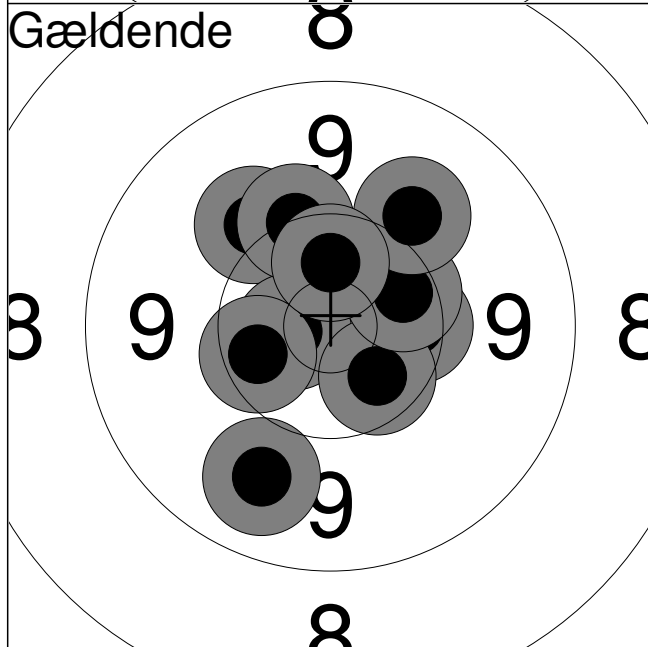

| | | |
|-----|-------|---|
| 11: | 10.1 | ↗ |
| 12: | 10.4 | → |
| 13: | *10.7 | ← |
| 14: | 9.8 | ↙ |
| 15: | 10.2 | ↗ |
| 16: | *10.5 | ↓ |
| 17: | 10.4 | ← |
| 18: | 10.4 | ↗ |
| 19: | 10.0 | ↗ |
| 20: | *10.5 | ↑ |

| | |
|-------|------|
| Serie | 99.0 |
|-------|------|

| | |
|-------|-------|
| Total | 195.0 |
|-------|-------|

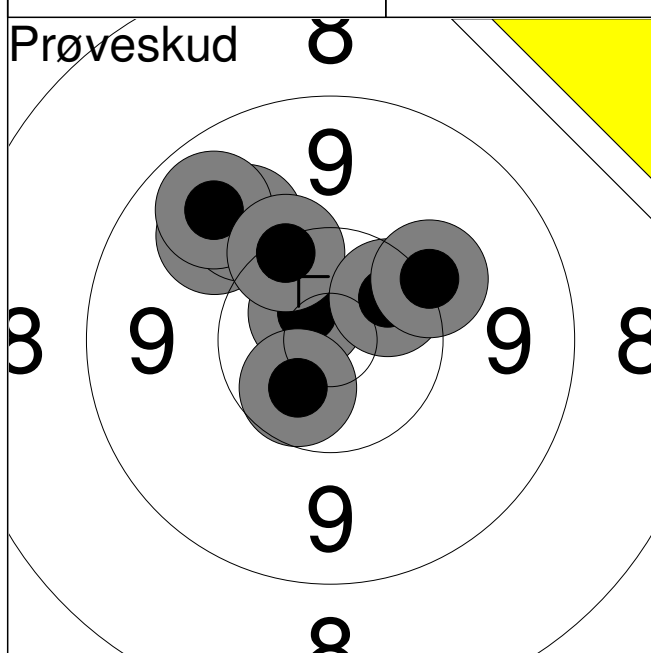

| | | |
|----|-------|---|
| 1: | 9.9 | ↗ |
| 2: | *10.7 | ↗ |
| 3: | *10.5 | ↘ |
| 4: | 9.9 | ↗ |
| 5: | 9.7 | ↗ |
| 6: | 10.3 | ↗ |
| 7: | *10.5 | ↗ |
| 8: | 10.1 | ↗ |

| | |
|-------|------|
| Serie | 77.0 |
| Total | 0.0 |

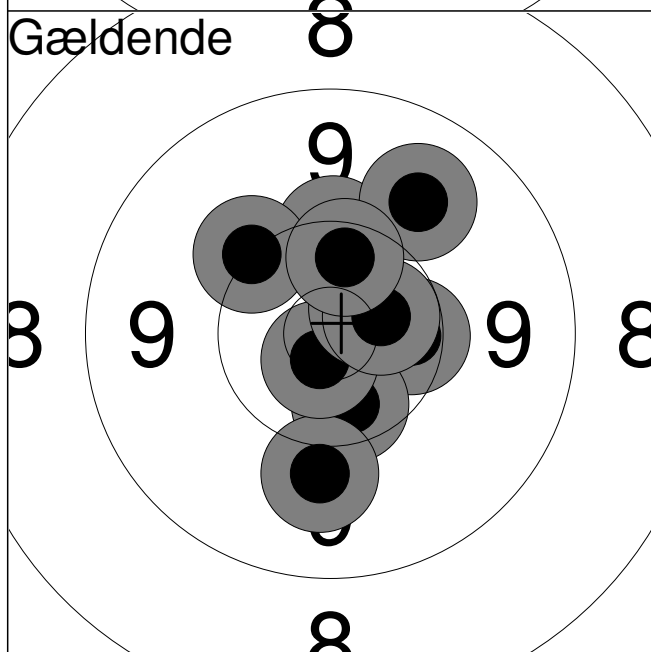

| | | |
|-----|-------|---|
| 1: | 10.3 | ↑ |
| 2: | 10.2 | ↗ |
| 3: | 10.4 | → |
| 4: | *10.4 | ↓ |
| 5: | 10.0 | ↓ |
| 6: | *10.8 | ↓ |
| 7: | *10.6 | ↗ |
| 8: | 9.8 | ↗ |
| 9: | *10.6 | → |
| 10: | 10.4 | ↑ |

| | |
|-------|------|
| Serie | 99.0 |
| Total | 99.0 |

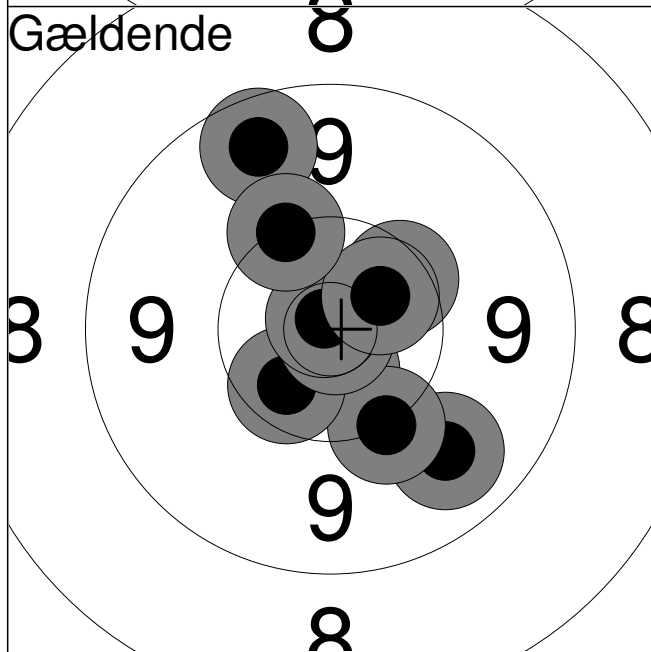

| | | |
|-----|-------|---|
| 11: | 9.8 | ↓ |
| 12: | *10.6 | ↓ |
| 13: | 10.2 | ↓ |
| 14: | *10.5 | ↘ |
| 15: | 10.3 | ↗ |
| 16: | *10.9 | ↓ |
| 17: | *10.9 | ↗ |
| 18: | *10.5 | ↗ |
| 19: | 9.5 | ↗ |
| 20: | 10.2 | ↗ |

| | |
|-------|-------|
| Serie | 98.0 |
| Total | 197.0 |

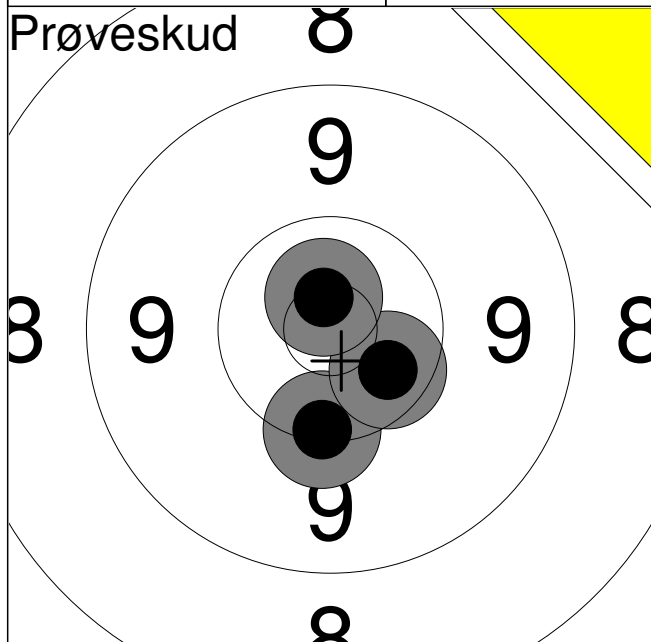

| | | |
|--------------|-------|-------------|
| 1: | 10.2 | ↓ |
| 2: | *10.5 | ↘ |
| 3: | *10.7 | ↑ |
| Serie | | 30.0 |
| Total | | 0.0 |

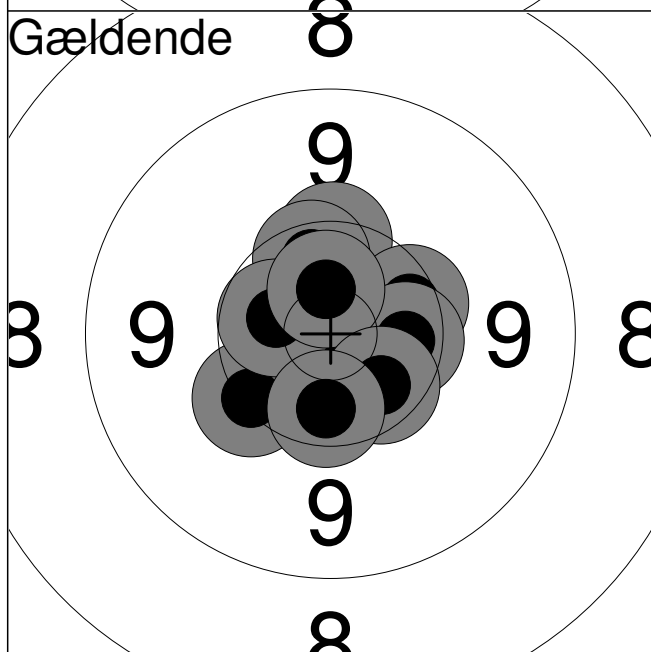

| | | |
|--------------|-------|--------------|
| 1: | 10.3 | ↑ |
| 2: | *10.9 | ↑ |
| 3: | 10.4 | → |
| 4: | 10.2 | ↙ |
| 5: | 10.4 | ↑ |
| 6: | *10.4 | → |
| 7: | *10.6 | ← |
| 8: | *10.6 | ↑ |
| 9: | *10.4 | ↘ |
| 10: | *10.4 | ↓ |
| Serie | | 100.0 |
| Total | | 100.0 |

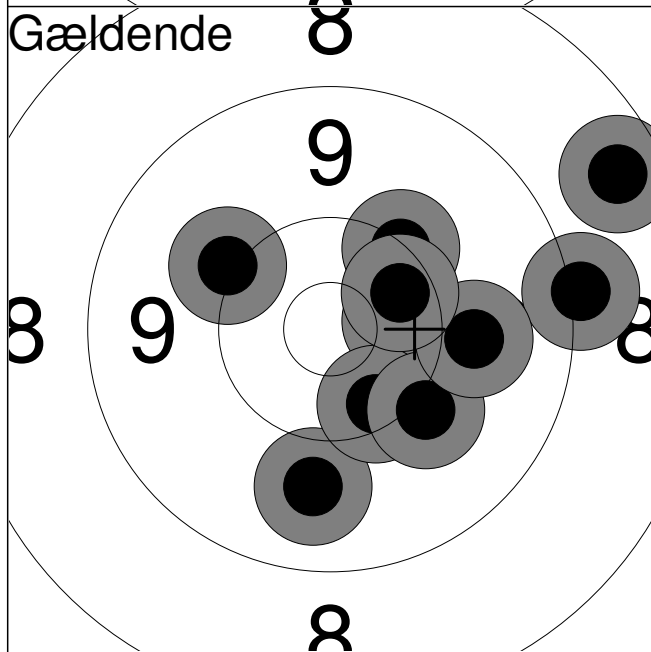

| | | |
|--------------|-------|--------------|
| 11: | 9.8 | ↓ |
| 12: | *10.5 | → |
| 13: | 9.1 | → |
| 14: | 10.1 | ↗ |
| 15: | 8.5 | ↗ |
| 16: | 10.3 | ↘ |
| 17: | 10.2 | ↗ |
| 18: | 10.1 | ↘ |
| 19: | 9.9 | → |
| 20: | 10.4 | ↗ |
| Serie | | 95.0 |
| Total | | 195.0 |

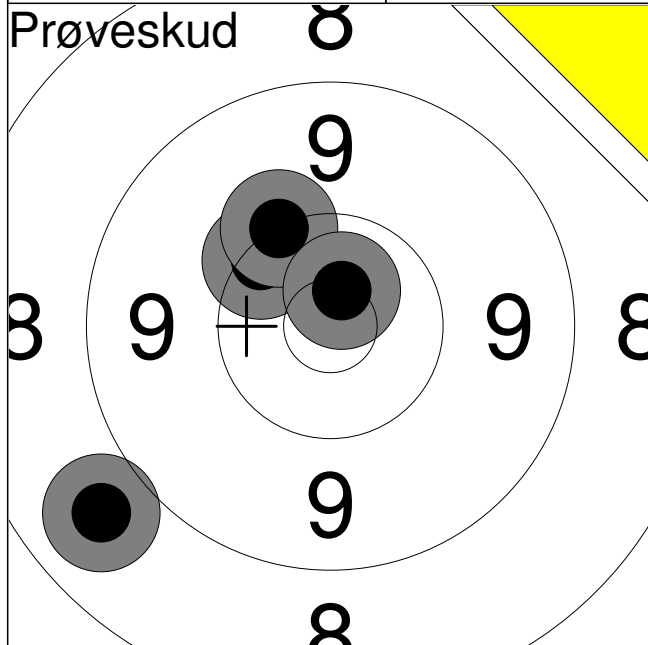

| | | |
|----|-------|---|
| 1: | 8.8 | ↙ |
| 2: | 10.3 | ↗ |
| 3: | 10.2 | ↗ |
| 4: | *10.7 | ↗ |

| | |
|-------|------|
| Serie | 38.0 |
|-------|------|

| | |
|-------|-----|
| Total | 0.0 |
|-------|-----|

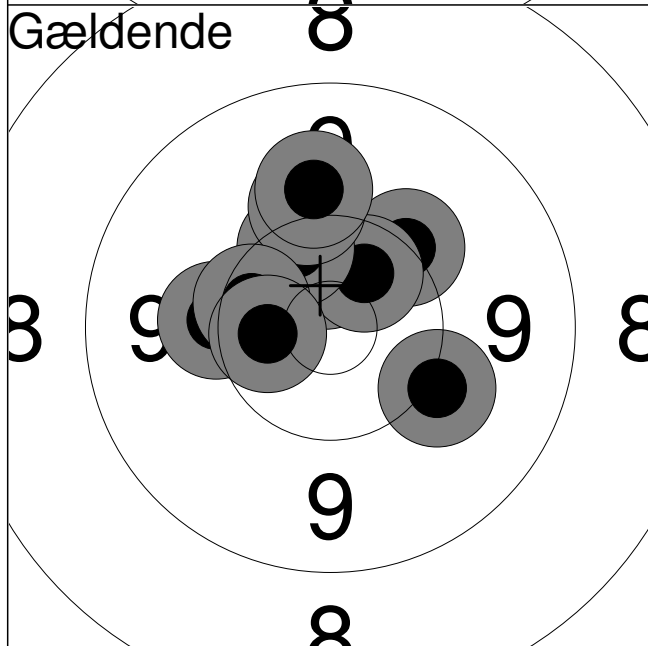

| | | |
|-----|-------|---|
| 1: | 10.2 | ↗ |
| 2: | *10.5 | ↑ |
| 3: | *10.5 | ↗ |
| 4: | 10.1 | ↙ |
| 5: | 10.1 | ↘ |
| 6: | 10.3 | ↗ |
| 7: | 10.1 | ↗ |
| 8: | 10.0 | ↑ |
| 9: | 10.4 | ↙ |
| 10: | *10.5 | ↙ |

| | |
|-------|-------|
| Serie | 100.0 |
|-------|-------|

| | |
|-------|-------|
| Total | 100.0 |
|-------|-------|

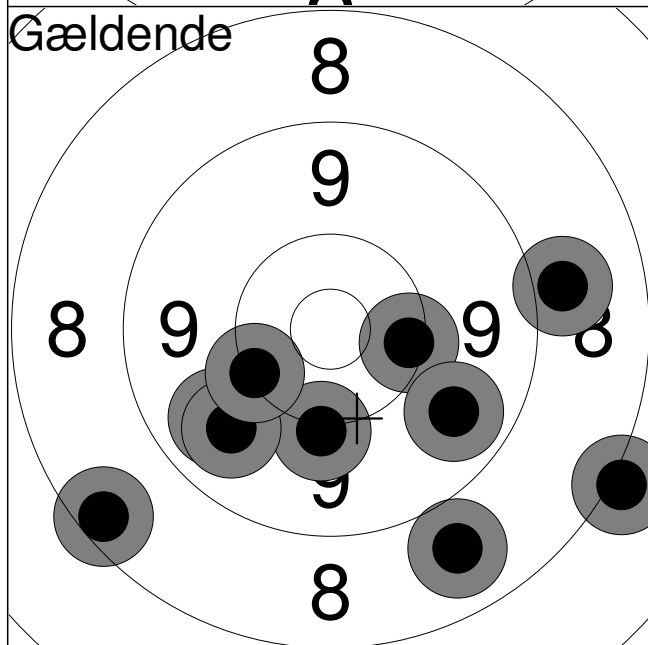

| | | |
|-----|------|---|
| 11: | 8.1 | ↘ |
| 12: | 8.4 | ↙ |
| 13: | 8.8 | ↘ |
| 14: | 9.7 | ↙ |
| 15: | 10.1 | ↘ |
| 16: | 8.9 | → |
| 17: | 9.8 | ↙ |
| 18: | 10.3 | → |
| 19: | 10.2 | ↙ |
| 20: | 9.7 | ↘ |

| | |
|-------|------|
| Serie | 89.0 |
|-------|------|

| | |
|-------|-------|
| Total | 189.0 |
|-------|-------|

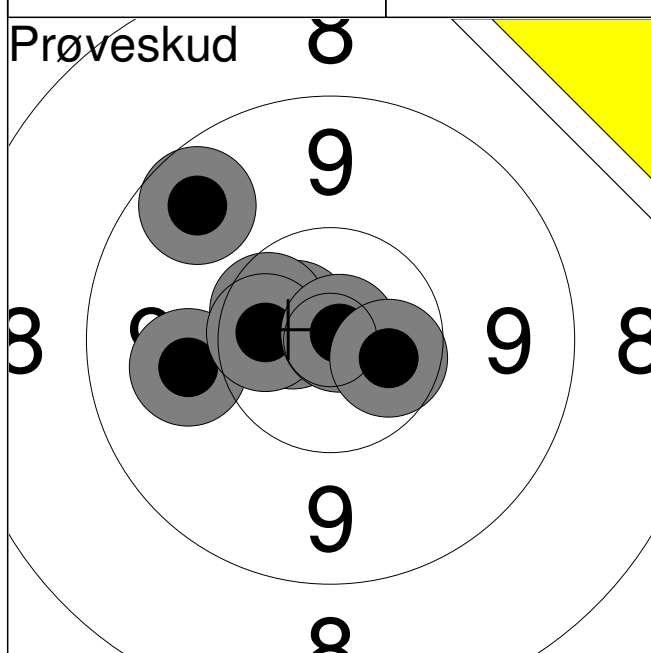

| | | |
|----|-------|---|
| 1: | 9.6 | ↗ |
| 2: | *10.7 | ↗ |
| 3: | *10.7 | ↗ |
| 4: | 9.9 | ↖ |
| 5: | *10.5 | ↗ |
| 6: | *10.5 | ↖ |
| 7: | *10.9 | ↗ |
| 8: | *10.5 | ↘ |

| | |
|-------|------|
| Serie | 78.0 |
| Total | 0.0 |

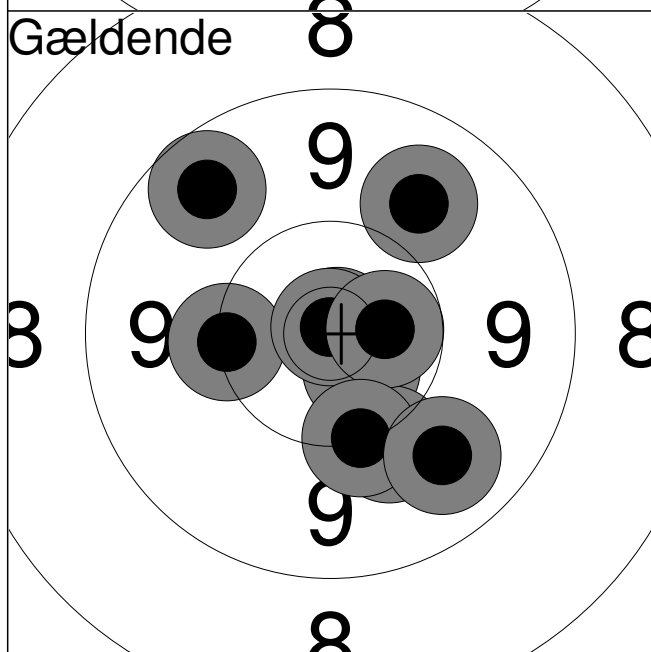

| | | |
|-----|-------|---|
| 1: | 10.2 | ↖ |
| 2: | 9.6 | ↗ |
| 3: | *10.9 | ↗ |
| 4: | 9.8 | ↗ |
| 5: | *10.6 | ↘ |
| 6: | 10.1 | ↘ |
| 7: | *10.9 | ↗ |
| 8: | *10.6 | → |
| 9: | 10.2 | ↘ |
| 10: | 9.8 | ↘ |

| | |
|-------|------|
| Serie | 97.0 |
| Total | 97.0 |

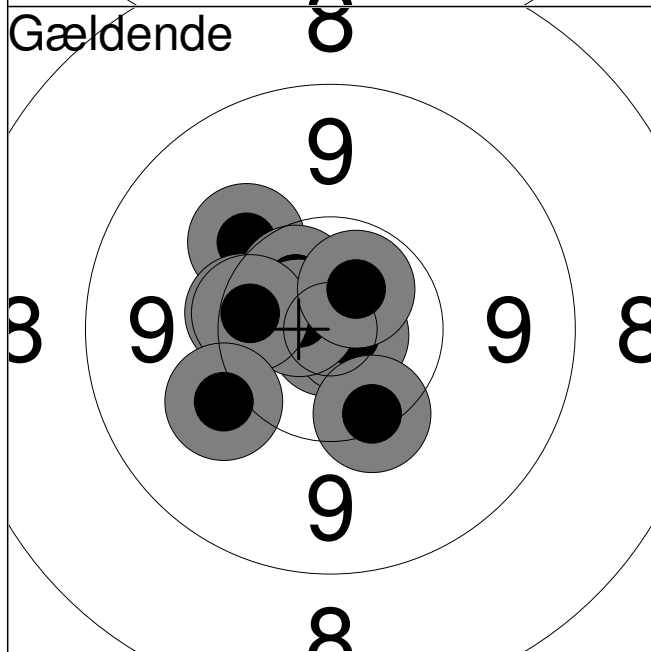

| | | |
|-----|-------|---|
| 11: | 10.1 | ↗ |
| 12: | *10.9 | ↘ |
| 13: | 10.3 | ↖ |
| 14: | *10.8 | ↘ |
| 15: | *10.6 | ↗ |
| 16: | *10.7 | ↖ |
| 17: | 10.4 | ↖ |
| 18: | *10.6 | ↗ |
| 19: | 10.0 | ↖ |
| 20: | 10.3 | ↘ |

| | |
|-------|-------|
| Serie | 100.0 |
| Total | 197.0 |

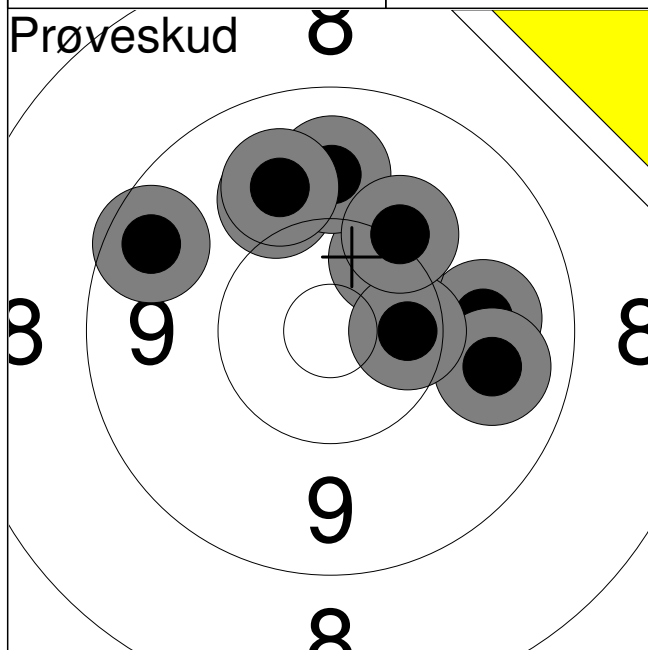

| | | |
|----|------|---|
| 1: | 9.9 | → |
| 2: | 10.3 | ↗ |
| 3: | 9.8 | → |
| 4: | 9.9 | ↗ |
| 5: | 10.4 | → |
| 6: | 9.8 | ↑ |
| 7: | 9.5 | ↖ |
| 8: | 10.1 | ↗ |
| 9: | 9.9 | ↗ |

| | |
|-------|------|
| Serie | 84.0 |
|-------|------|

| | |
|-------|-----|
| Total | 0.0 |
|-------|-----|

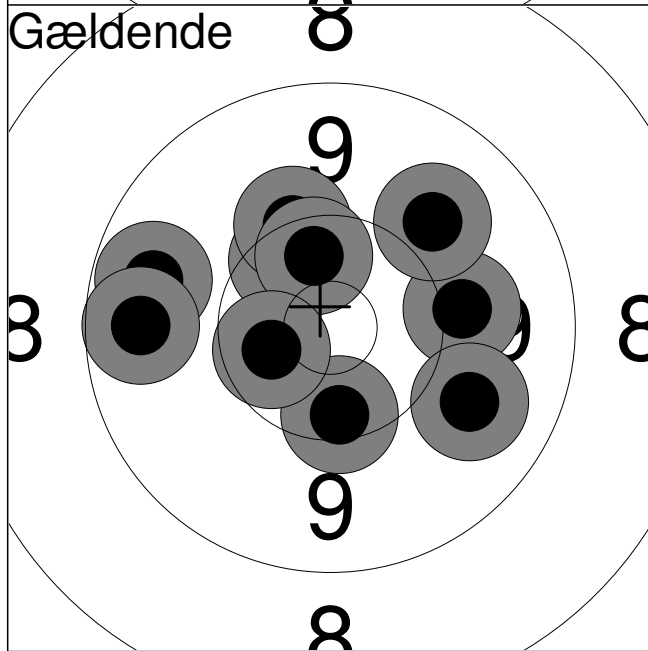

| | | |
|-----|-------|---|
| 1: | 10.0 | → |
| 2: | 9.9 | ↗ |
| 3: | 10.4 | ↗ |
| 4: | 10.2 | ↗ |
| 5: | 9.6 | ↖ |
| 6: | *10.4 | ↗ |
| 7: | 9.8 | ↘ |
| 8: | 9.6 | ← |
| 9: | 10.3 | ↓ |
| 10: | *10.5 | ← |

| | |
|-------|------|
| Serie | 96.0 |
|-------|------|

| | |
|-------|------|
| Total | 96.0 |
|-------|------|

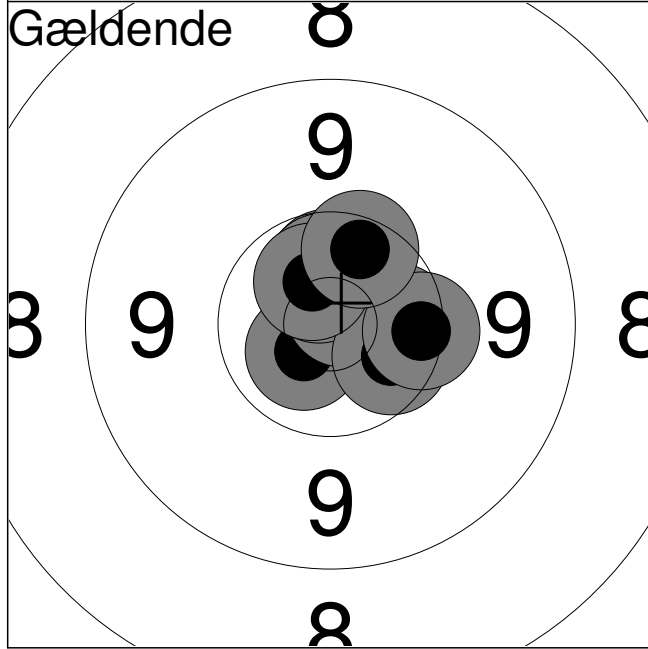

| | | |
|-----|-------|---|
| 11: | *10.7 | ↖ |
| 12: | *10.6 | ↑ |
| 13: | *10.5 | → |
| 14: | *10.6 | ↑ |
| 15: | *10.8 | ↗ |
| 16: | *10.7 | ↗ |
| 17: | *10.5 | ↘ |
| 18: | *10.6 | ↗ |
| 19: | 10.3 | → |
| 20: | 10.4 | ↗ |

| | |
|-------|-------|
| Serie | 100.0 |
|-------|-------|

| | |
|-------|-------|
| Total | 196.0 |
|-------|-------|

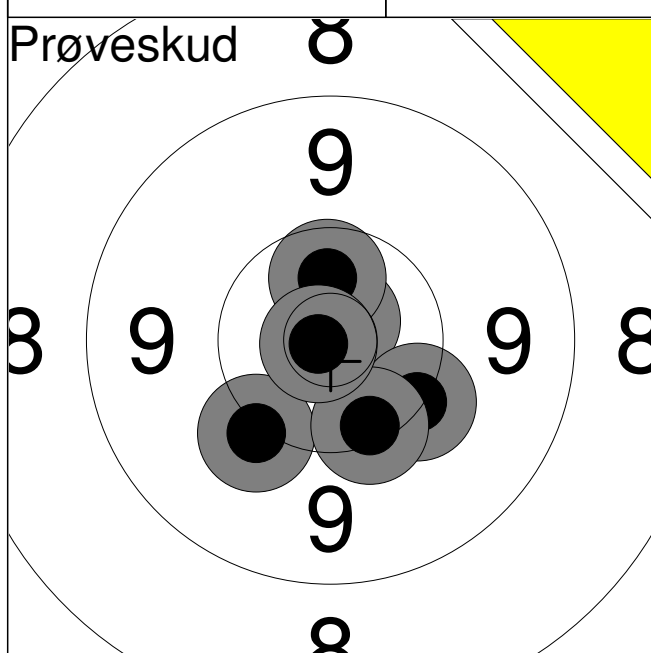

| | | |
|-------|-------|------|
| 1: | *10.8 | ↗ |
| 2: | 10.1 | ↘ |
| 3: | 10.2 | ↘ |
| 4: | *10.5 | ↑ |
| 5: | 10.3 | ↘ |
| 6: | *10.9 | ← |
| Serie | | 60.0 |
| Total | | 0.0 |

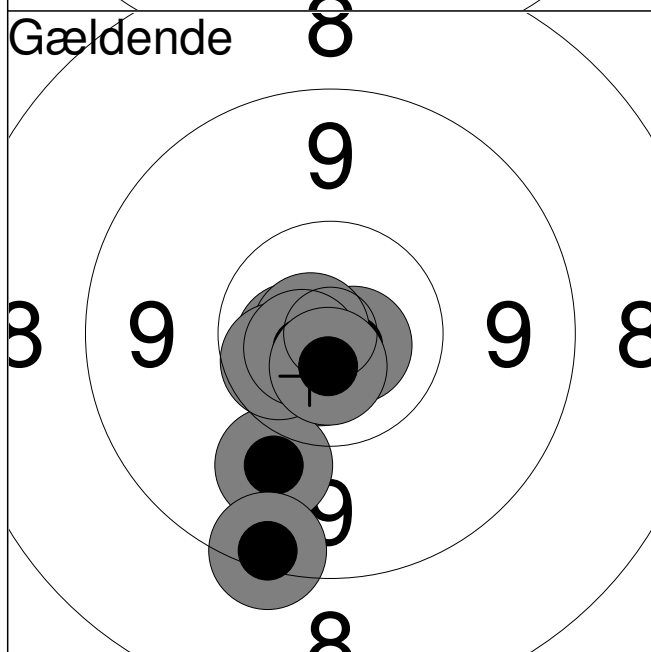

| | | |
|-------|-------|------|
| 1: | *10.8 | → |
| 2: | *10.7 | ← |
| 3: | *10.8 | ← |
| 4: | *10.7 | ↘ |
| 5: | *10.7 | ↘ |
| 6: | 9.9 | ↘ |
| 7: | 9.3 | ↘ |
| 8: | *10.5 | ← |
| 9: | *10.7 | ← |
| 10: | *10.7 | ↓ |
| Serie | | 98.0 |
| Total | | 98.0 |

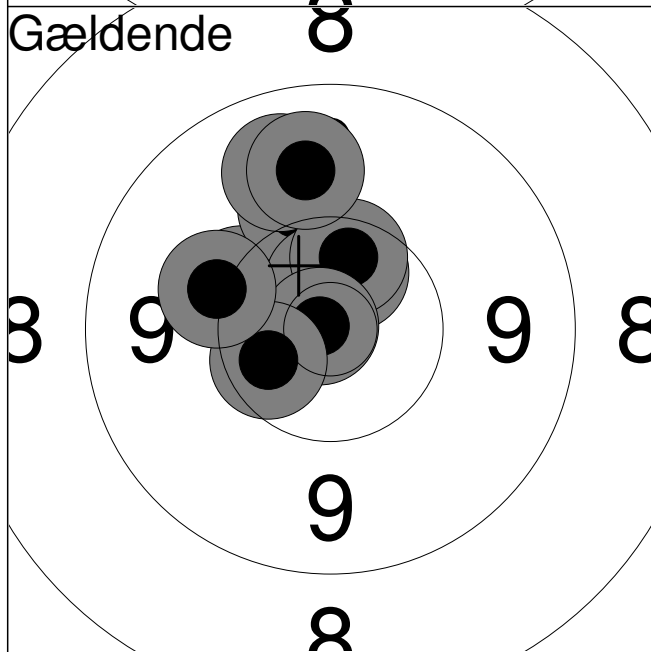

| | | |
|-------|-------|-------|
| 11: | 10.3 | ↖ |
| 12: | 10.1 | ↑ |
| 13: | *10.5 | ↑ |
| 14: | *10.6 | ↑ |
| 15: | 9.8 | ↑ |
| 16: | *10.4 | ↑ |
| 17: | *10.9 | ← |
| 18: | 9.8 | ↑ |
| 19: | *10.5 | ← |
| 20: | 10.1 | ↖ |
| Serie | | 98.0 |
| Total | | 196.0 |

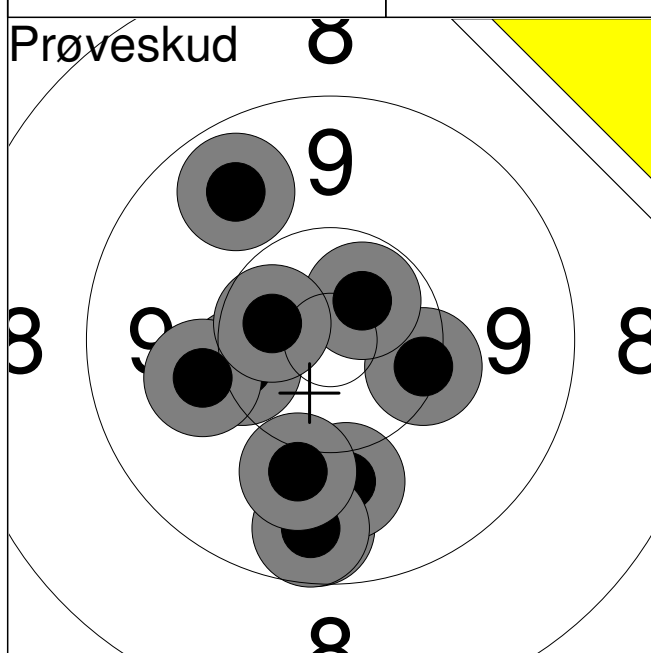

| | | |
|-----|-------|---|
| 1: | 10.3 | → |
| 2: | *10.6 | ↗ |
| 3: | 10.3 | ← |
| 4: | 9.6 | ↓ |
| 5: | 10.0 | ← |
| 6: | 10.0 | ↓ |
| 7: | 9.6 | ↓ |
| 8: | *10.5 | ↖ |
| 9: | 9.7 | ↗ |
| 10: | 10.0 | ↓ |

| | |
|-------|------|
| Serie | 97.0 |
|-------|------|

| | |
|-------|-----|
| Total | 0.0 |
|-------|-----|

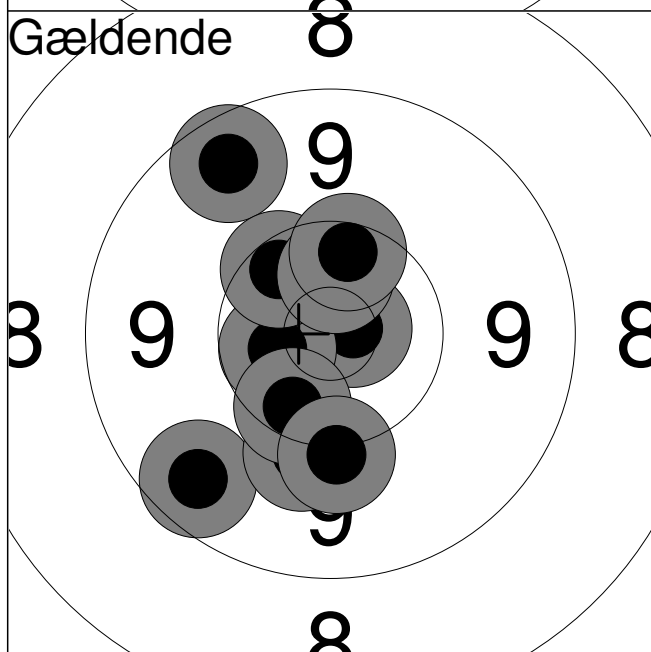

| | | |
|-----|-------|---|
| 1: | 9.5 | ↙ |
| 2: | *10.8 | → |
| 3: | 10.1 | ↓ |
| 4: | 9.5 | ↗ |
| 5: | *10.6 | ← |
| 6: | 10.4 | ↗ |
| 7: | 10.4 | ↙ |
| 8: | *10.5 | ↑ |
| 9: | 10.4 | ↑ |
| 10: | 10.1 | ↓ |

| | |
|-------|------|
| Serie | 98.0 |
|-------|------|

| | |
|-------|------|
| Total | 98.0 |
|-------|------|

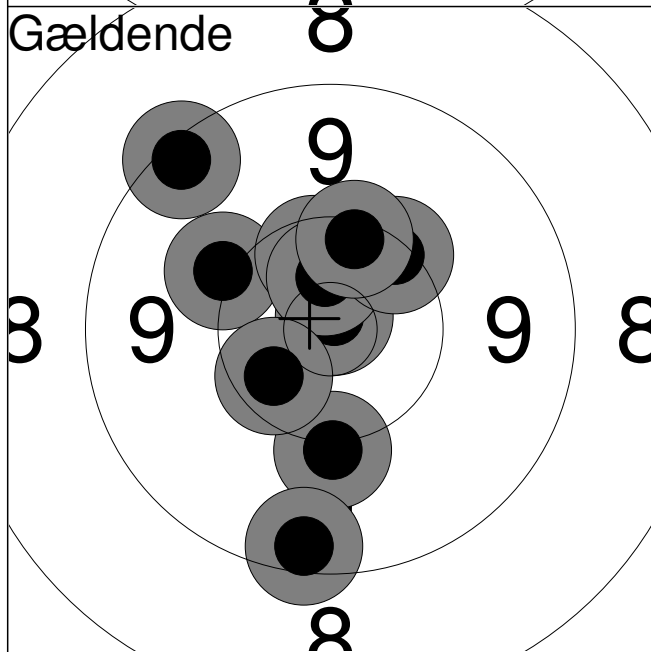

| | | |
|-----|-------|---|
| 11: | 10.1 | ↓ |
| 12: | 10.1 | ↖ |
| 13: | 10.4 | ↑ |
| 14: | 9.4 | ↓ |
| 15: | 9.3 | ↖ |
| 16: | *10.9 | ↑ |
| 17: | *10.6 | ↑ |
| 18: | 10.3 | ↗ |
| 19: | 10.3 | ↑ |
| 20: | *10.4 | ↙ |

| | |
|-------|------|
| Serie | 98.0 |
|-------|------|

| | |
|-------|-------|
| Total | 196.0 |
|-------|-------|

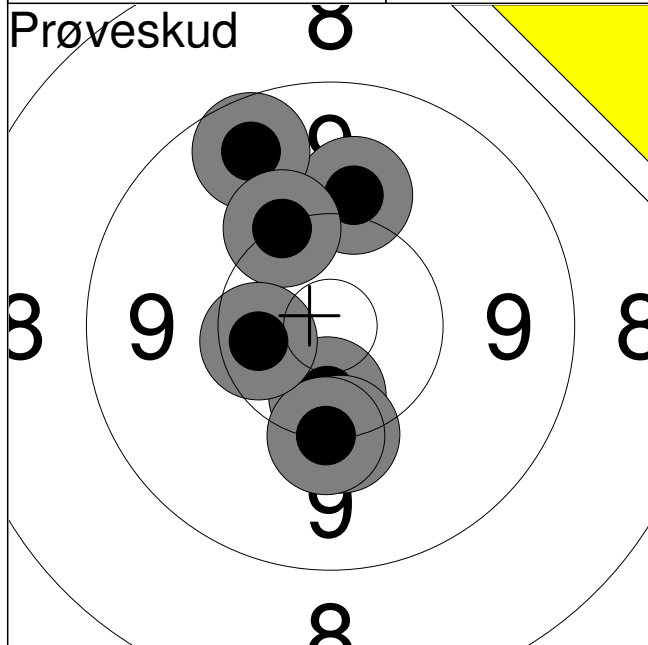

| | | |
|--------------|-------|-------------|
| 1: | *10.5 | ↓ |
| 2: | 10.2 | ↓ |
| 3: | 10.2 | ↓ |
| 4: | 10.0 | ↑ |
| 5: | 9.6 | ↑ |
| 6: | 10.2 | ↑ |
| 7: | *10.4 | ← |
| Serie | | 69.0 |
| Total | | 0.0 |

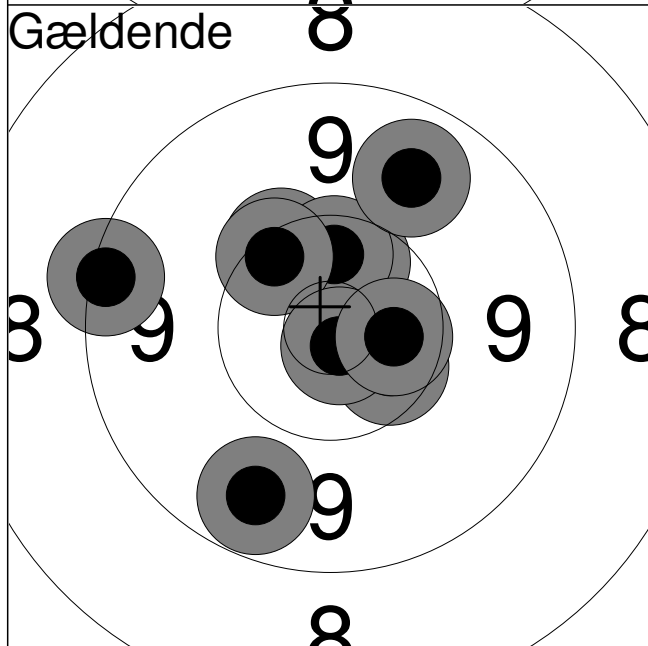

| | | |
|--------------|-------|-------------|
| 1: | 10.3 | ↑ |
| 2: | *10.5 | ↑ |
| 3: | *10.4 | ↓ |
| 4: | *10.4 | ↑ |
| 5: | 9.7 | ↑ |
| 6: | 9.3 | ← |
| 7: | 10.3 | ↑ |
| 8: | 9.6 | ↓ |
| 9: | *10.8 | ↓ |
| 10: | *10.5 | → |
| Serie | | 97.0 |
| Total | | 97.0 |

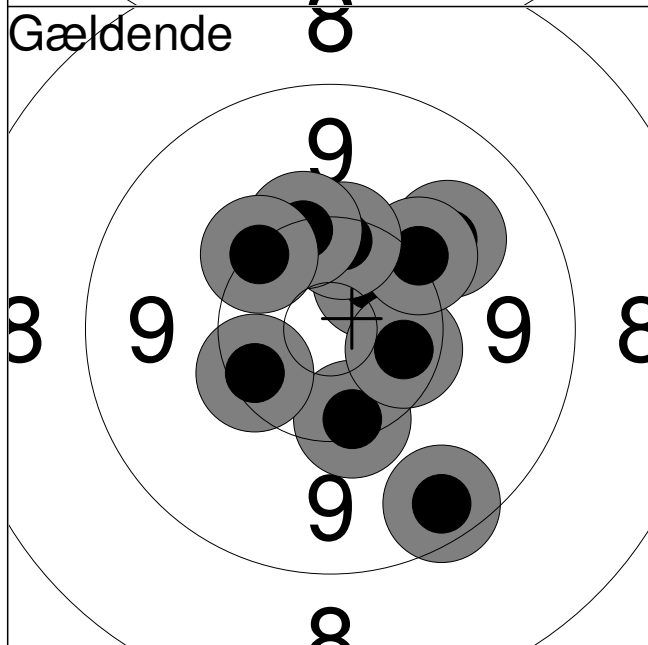

| | | |
|--------------|-------|--------------|
| 11: | *10.5 | ↑ |
| 12: | 10.3 | ↓ |
| 13: | 9.9 | ↗ |
| 14: | 9.5 | ↓ |
| 15: | *10.4 | → |
| 16: | 10.1 | ↗ |
| 17: | 10.3 | ↑ |
| 18: | 10.3 | ← |
| 19: | 10.2 | ↑ |
| 20: | 10.2 | ↗ |
| Serie | | 98.0 |
| Total | | 195.0 |

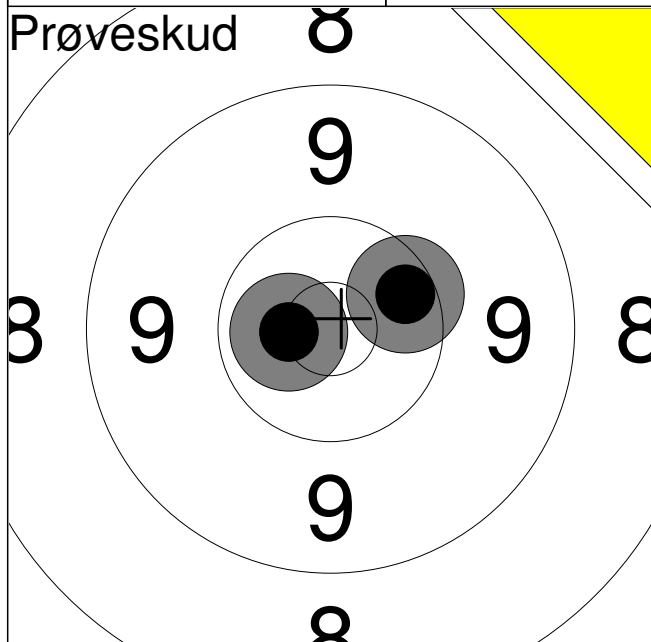

| | | |
|--------------|-------|-------------|
| 1: | *10.7 | ← |
| 2: | 10.4 | → |
| Serie | | 20.0 |
| Total | | 0.0 |

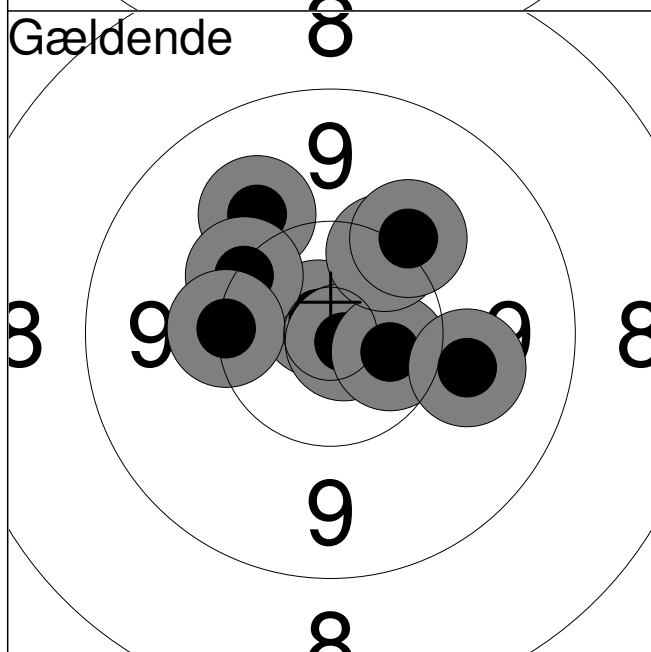

| | | |
|--------------|-------|--------------|
| 1: | 10.0 | ↗ |
| 2: | *10.9 | ↗ |
| 3: | *10.8 | ↗ |
| 4: | *10.8 | ↘ |
| 5: | *10.5 | ↘ |
| 6: | 10.3 | ↗ |
| 7: | 10.1 | ↗ |
| 8: | 10.2 | ↗ |
| 9: | 10.2 | ← |
| 10: | 10.0 | ↘ |
| Serie | | 100.0 |
| Total | | 100.0 |

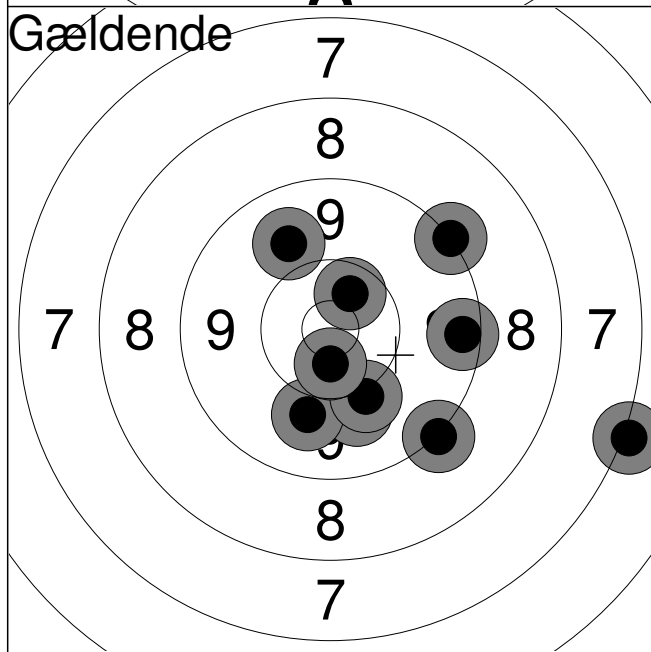

| | | |
|--------------|-------|--------------|
| 11: | 10.0 | ↘ |
| 12: | 9.9 | ↘ |
| 13: | 10.1 | ↘ |
| 14: | 9.9 | ↗ |
| 15: | 7.1 | ↘ |
| 16: | 9.4 | → |
| 17: | 9.2 | ↘ |
| 18: | 9.2 | ↗ |
| 19: | *10.5 | ↘ |
| 20: | *10.5 | ↗ |
| Serie | | 92.0 |
| Total | | 192.0 |

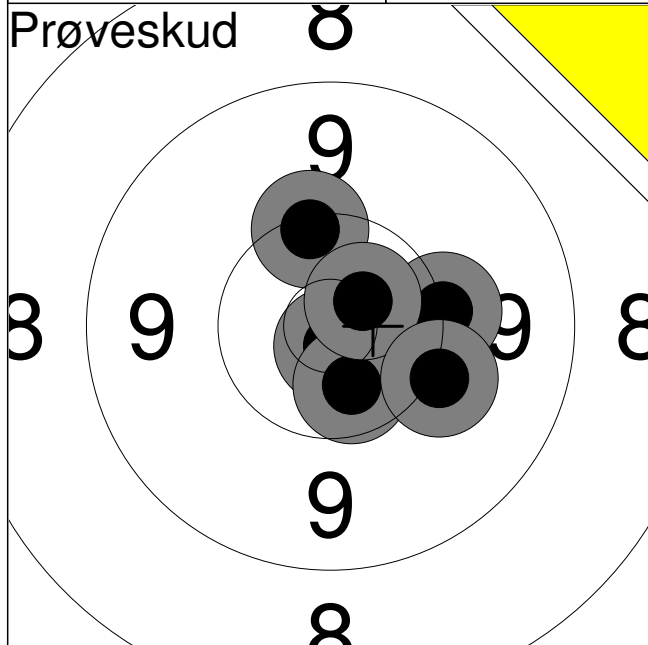

| | | |
|----|-------|---|
| 1: | *10.8 | ↓ |
| 2: | *10.5 | ↓ |
| 3: | 10.2 | → |
| 4: | 10.3 | ↑ |
| 5: | *10.7 | ↗ |
| 6: | 10.1 | ↘ |

| | |
|-------|------|
| Serie | 60.0 |
| Total | 0.0 |

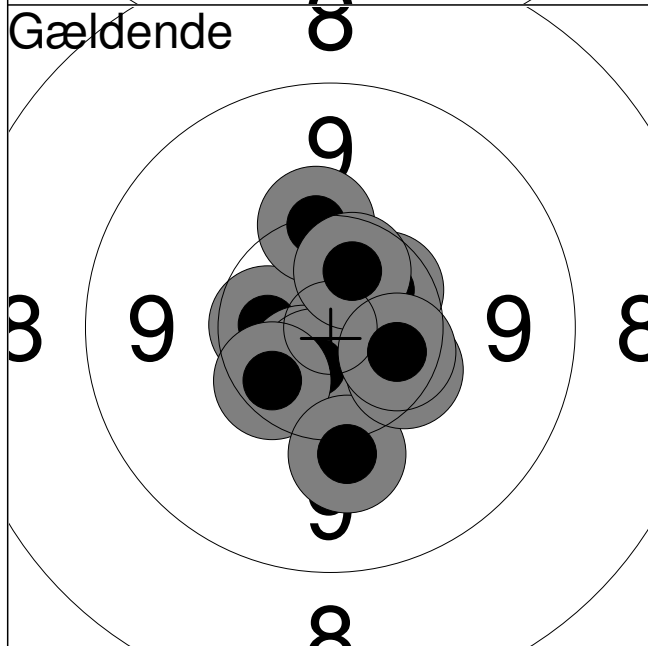

| | | |
|-----|-------|---|
| 1: | *10.5 | ← |
| 2: | *10.6 | ↙ |
| 3: | *10.5 | ↗ |
| 4: | *10.7 | ↓ |
| 5: | 10.2 | ↑ |
| 6: | 10.4 | ↙ |
| 7: | 10.1 | ↓ |
| 8: | *10.5 | ↑ |
| 9: | 10.4 | ↘ |
| 10: | *10.5 | ↘ |

| | |
|-------|-------|
| Serie | 100.0 |
| Total | 100.0 |

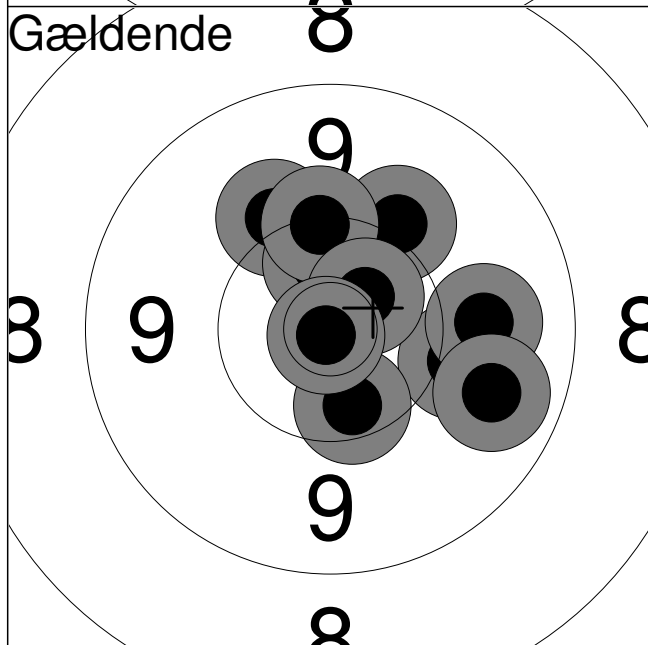

| | | |
|-----|-------|---|
| 11: | 10.0 | → |
| 12: | 10.1 | ↗ |
| 13: | 10.1 | ↗ |
| 14: | 9.9 | → |
| 15: | 10.4 | ↓ |
| 16: | 9.7 | ↘ |
| 17: | *10.5 | ↑ |
| 18: | 10.2 | ↑ |
| 19: | *10.6 | ↗ |
| 20: | *10.9 | ↙ |

| | |
|-------|-------|
| Serie | 98.0 |
| Total | 198.0 |



| | | |
|----|-------|---|
| 1: | 10.1 | ↖ |
| 2: | 10.4 | ↙ |
| 3: | *10.5 | ↓ |
| 4: | 10.3 | ↗ |
| 5: | *10.6 | ↘ |
| 6: | *10.5 | ← |

| | |
|-------|------|
| Serie | 60.0 |
| Total | 0.0 |

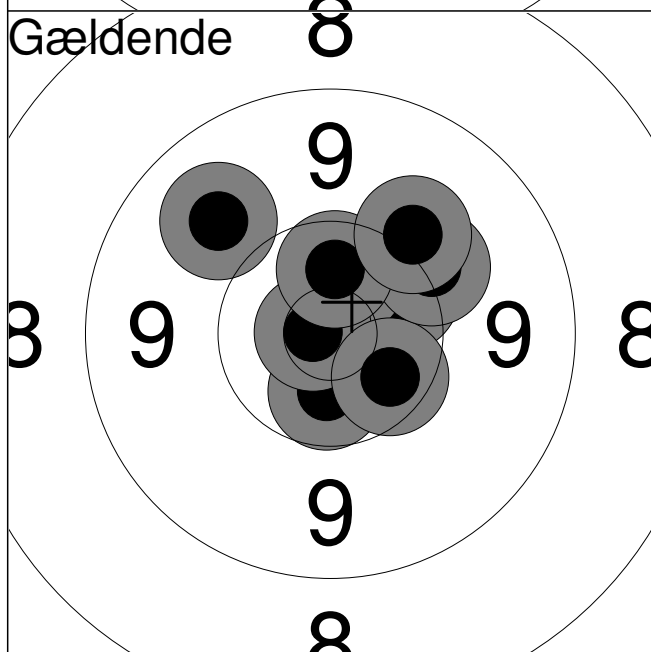

| | | |
|-----|-------|---|
| 1: | *10.7 | ↗ |
| 2: | 10.4 | ↗ |
| 3: | *10.5 | ↓ |
| 4: | *10.5 | ↑ |
| 5: | 9.8 | ↗ |
| 6: | *10.8 | ← |
| 7: | *10.4 | ↘ |
| 8: | 10.1 | ↗ |
| 9: | *10.5 | ↑ |
| 10: | 10.0 | ↗ |

| | |
|-------|------|
| Serie | 99.0 |
| Total | 99.0 |

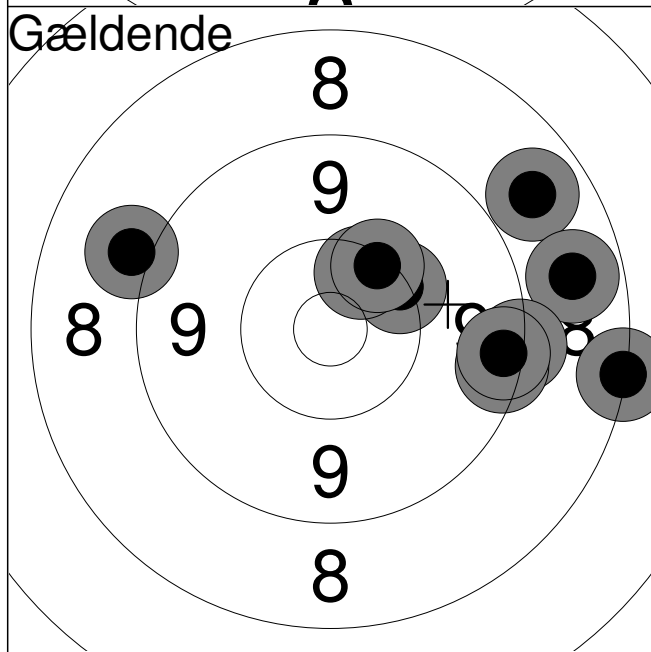

| | | |
|-----|------|---|
| 11: | 8.7 | ↗ |
| 12: | 10.2 | ↗ |
| 13: | 9.0 | ↖ |
| 14: | 8.7 | → |
| 15: | 8.2 | → |
| 16: | 10.4 | ↗ |
| 17: | 9.2 | → |
| 18: | 9.4 | → |
| 19: | 9.4 | → |
| 20: | 10.3 | ↗ |

| | |
|-------|-------|
| Serie | 90.0 |
| Total | 189.0 |

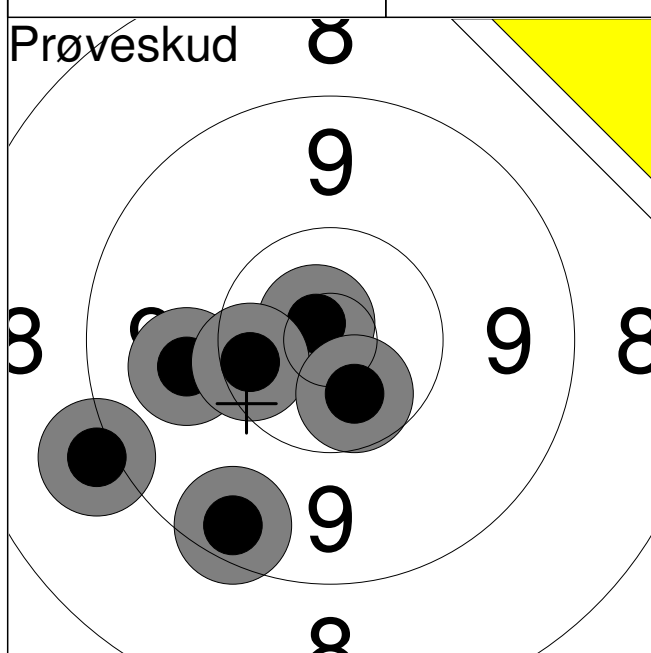

| | | |
|----|-------|---|
| 1: | 9.0 | ↙ |
| 2: | 9.4 | ↘ |
| 3: | 9.9 | ← |
| 4: | *10.8 | ↗ |
| 5: | 10.4 | ← |
| 6: | *10.5 | ↘ |

| | |
|-------|------|
| Serie | 57.0 |
| Total | 0.0 |

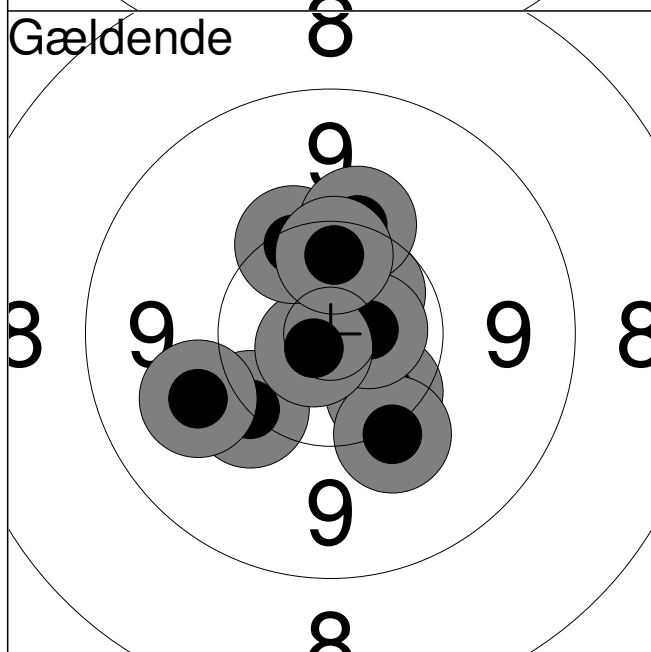

| | | |
|-----|-------|---|
| 1: | 10.4 | ↘ |
| 2: | 10.2 | ↙ |
| 3: | 10.1 | ↘ |
| 4: | *10.6 | ↗ |
| 5: | *10.7 | → |
| 6: | *10.8 | ↙ |
| 7: | 10.3 | ↗ |
| 8: | 10.2 | ↗ |
| 9: | 10.4 | ↗ |
| 10: | 9.9 | ↙ |

| | |
|-------|------|
| Serie | 99.0 |
| Total | 99.0 |

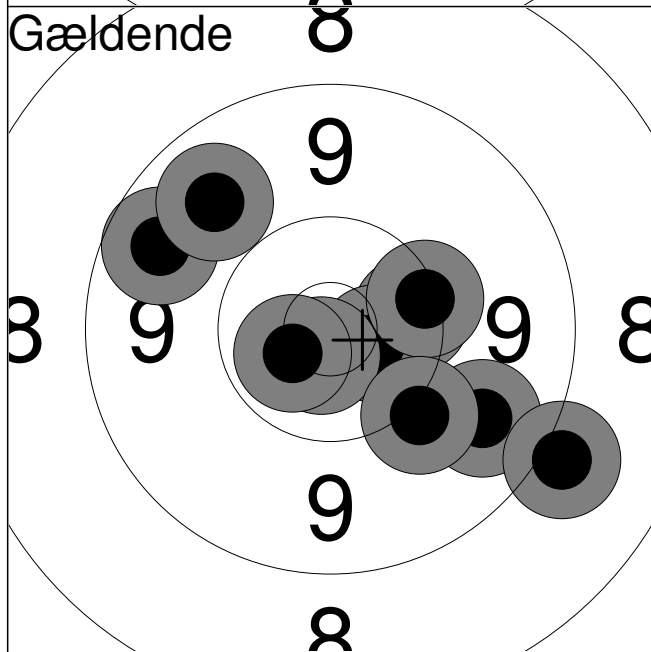

| | | |
|-----|-------|---|
| 11: | 10.4 | → |
| 12: | *10.6 | → |
| 13: | 9.7 | ↘ |
| 14: | 9.0 | ↘ |
| 15: | 10.3 | → |
| 16: | *10.8 | ↙ |
| 17: | 10.1 | ↘ |
| 18: | 9.6 | ↗ |
| 19: | *10.6 | ↙ |
| 20: | 9.7 | ↗ |

| | |
|-------|-------|
| Serie | 96.0 |
| Total | 195.0 |

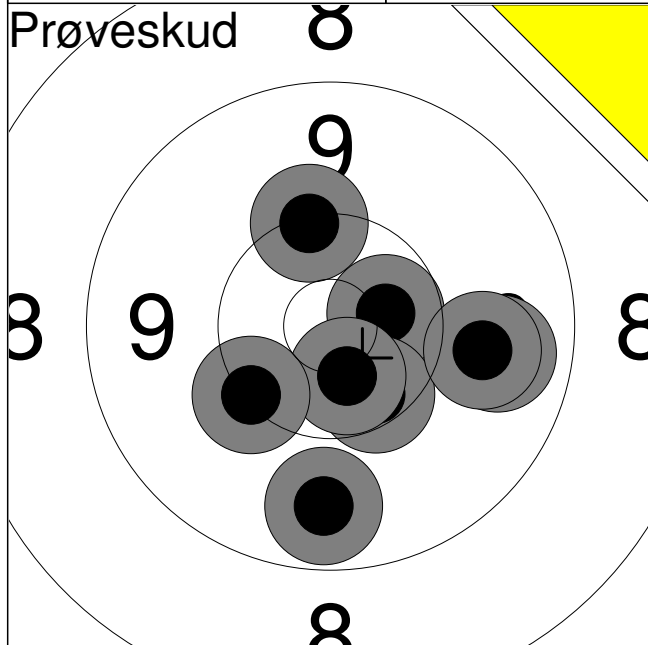

| | | |
|----|-------|---|
| 1: | *10.6 | → |
| 2: | 10.4 | ↘ |
| 3: | *10.6 | ↘ |
| 4: | 9.7 | ↘ |
| 5: | 9.7 | → |
| 6: | 10.2 | ↙ |
| 7: | 9.9 | → |
| 8: | 10.2 | ↑ |

| | |
|-------|------|
| Serie | 77.0 |
| Total | 0.0 |

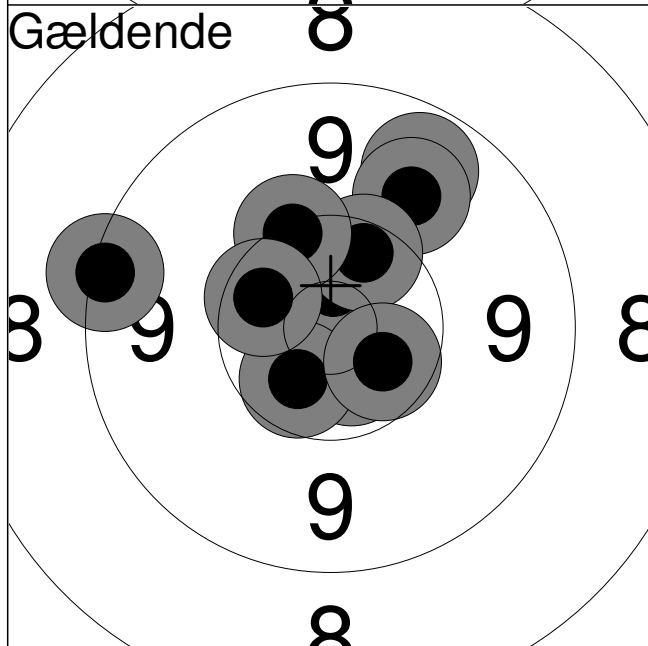

| | | |
|-----|-------|---|
| 1: | 9.7 | ↗ |
| 2: | 9.9 | ↗ |
| 3: | *10.6 | ↘ |
| 4: | *10.7 | ↑ |
| 5: | 10.4 | ↗ |
| 6: | *10.5 | ↘ |
| 7: | 10.2 | ↗ |
| 8: | 9.3 | ← |
| 9: | *10.4 | ↗ |
| 10: | *10.5 | ↘ |

| | |
|-------|------|
| Serie | 97.0 |
| Total | 97.0 |

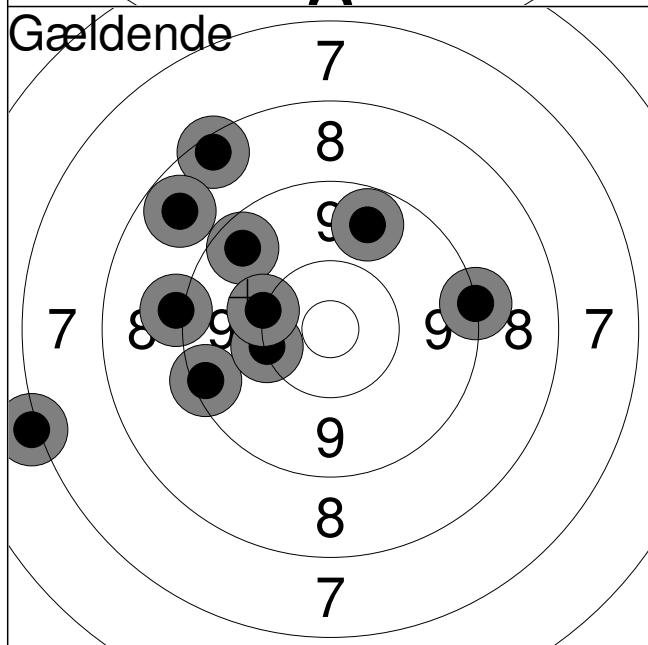

| | | |
|-----|------|---|
| 11: | 9.2 | → |
| 12: | 9.3 | ← |
| 13: | 10.2 | ← |
| 14: | 9.6 | ↑ |
| 15: | 8.4 | ↗ |
| 16: | 8.6 | ↗ |
| 17: | 7.1 | ← |
| 18: | 9.5 | ↗ |
| 19: | 9.1 | ← |
| 20: | 10.1 | ← |

| | |
|-------|-------|
| Serie | 88.0 |
| Total | 185.0 |

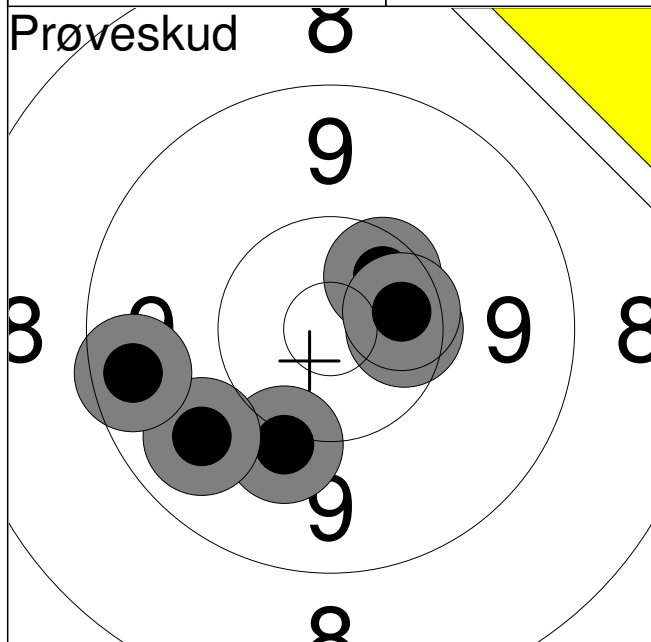

| | | |
|----|-------|---|
| 1: | 10.1 | ↓ |
| 2: | 9.8 | ↙ |
| 3: | 9.5 | ← |
| 4: | *10.4 | ↗ |
| 5: | *10.4 | → |
| 6: | *10.4 | → |

| | |
|-------|------|
| Serie | 58.0 |
| Total | 0.0 |

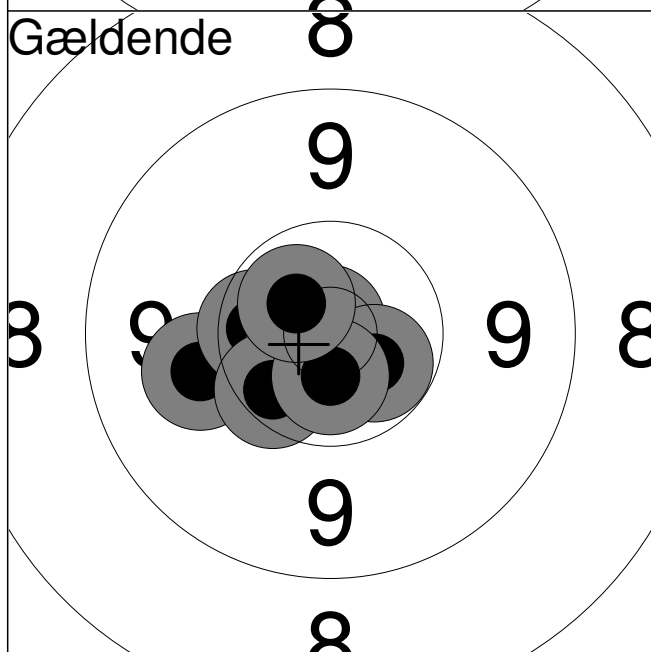

| | | |
|-----|-------|---|
| 1: | *10.8 | ↓ |
| 2: | *10.6 | ← |
| 3: | 10.0 | ← |
| 4: | *10.4 | ← |
| 5: | *10.9 | ↗ |
| 6: | *10.6 | ↘ |
| 7: | *10.6 | ↙ |
| 8: | 10.4 | ↙ |
| 9: | *10.7 | ↓ |
| 10: | *10.6 | ↗ |

| | |
|-------|-------|
| Serie | 100.0 |
| Total | 100.0 |

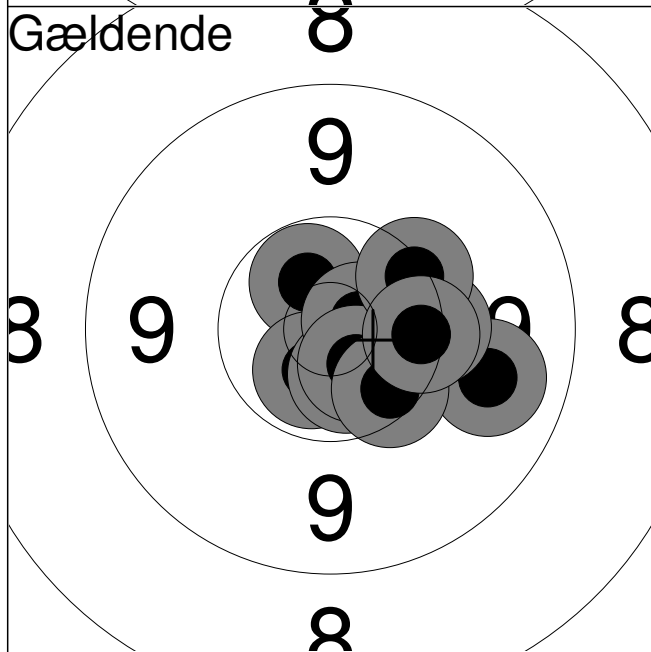

| | | |
|-----|-------|---|
| 11: | *10.6 | ↗ |
| 12: | *10.6 | ↓ |
| 13: | 9.8 | ↘ |
| 14: | *10.6 | ↙ |
| 15: | *10.7 | → |
| 16: | 10.2 | → |
| 17: | *10.6 | ↙ |
| 18: | 10.3 | ↗ |
| 19: | 10.4 | ↘ |
| 20: | 10.3 | → |

| | |
|-------|-------|
| Serie | 99.0 |
| Total | 199.0 |

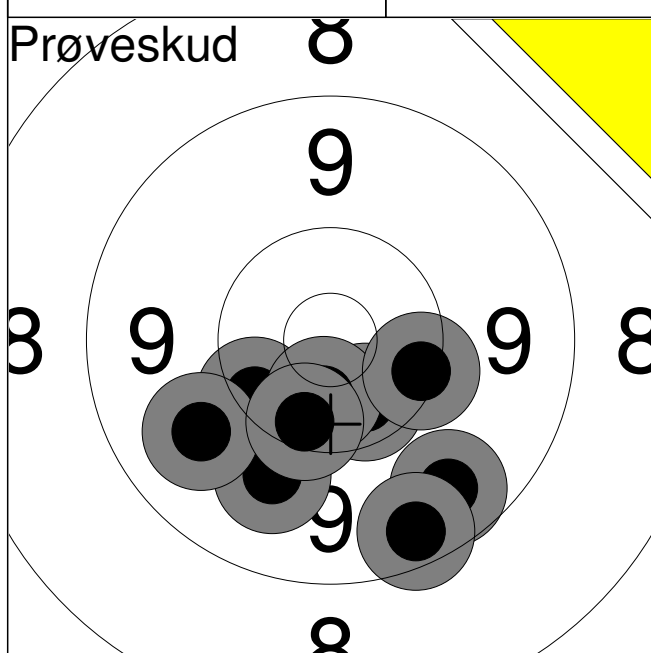

| | | |
|----|-------|---|
| 1: | 9.6 | ↘ |
| 2: | 9.4 | ↘ |
| 3: | 9.9 | ↘ |
| 4: | 10.3 | ↙ |
| 5: | 9.8 | ↙ |
| 6: | *10.5 | ↘ |
| 7: | *10.6 | ↘ |
| 8: | 10.3 | ↘ |
| 9: | 10.3 | → |

| | |
|-------|------|
| Serie | 86.0 |
| Total | 0.0 |

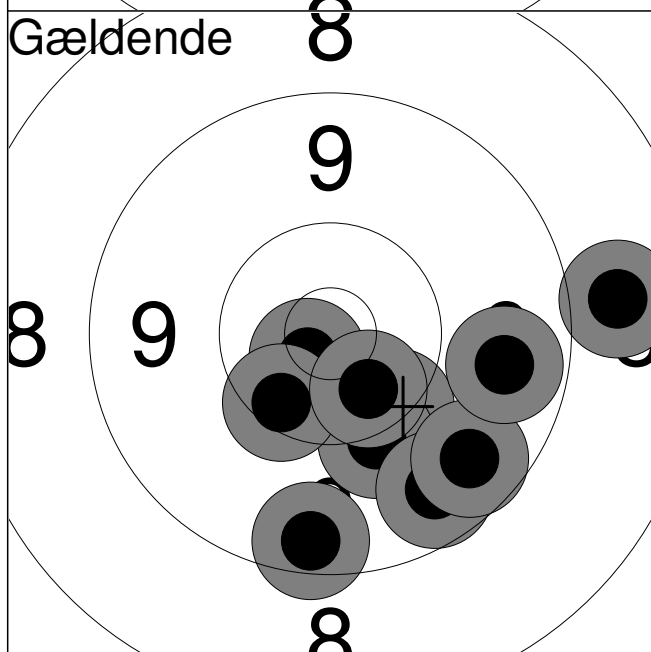

| | | |
|-----|-------|---|
| 1: | *10.7 | ↙ |
| 2: | 8.8 | → |
| 3: | 10.3 | ↘ |
| 4: | 10.1 | ↘ |
| 5: | 9.6 | ↘ |
| 6: | 9.4 | ↘ |
| 7: | 9.6 | ↘ |
| 8: | 10.3 | ↙ |
| 9: | *10.5 | ↘ |
| 10: | 9.7 | → |

| | |
|-------|------|
| Serie | 94.0 |
| Total | 94.0 |

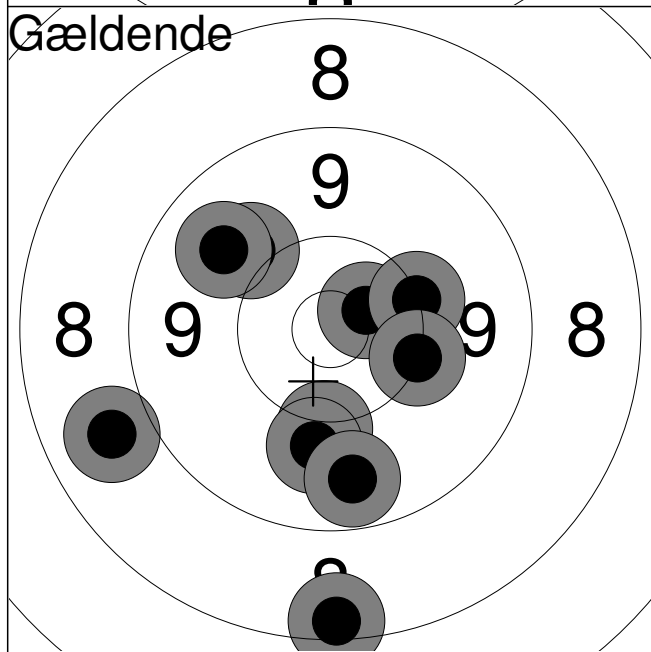

| | | |
|-----|-------|---|
| 11: | 8.3 | ↓ |
| 12: | 10.0 | ↗ |
| 13: | 9.8 | ↗ |
| 14: | *10.6 | → |
| 15: | 10.1 | ↓ |
| 16: | 10.2 | → |
| 17: | 10.2 | → |
| 18: | 9.9 | ↓ |
| 19: | 8.8 | ↙ |
| 20: | 9.6 | ↓ |

| | |
|-------|-------|
| Serie | 93.0 |
| Total | 187.0 |

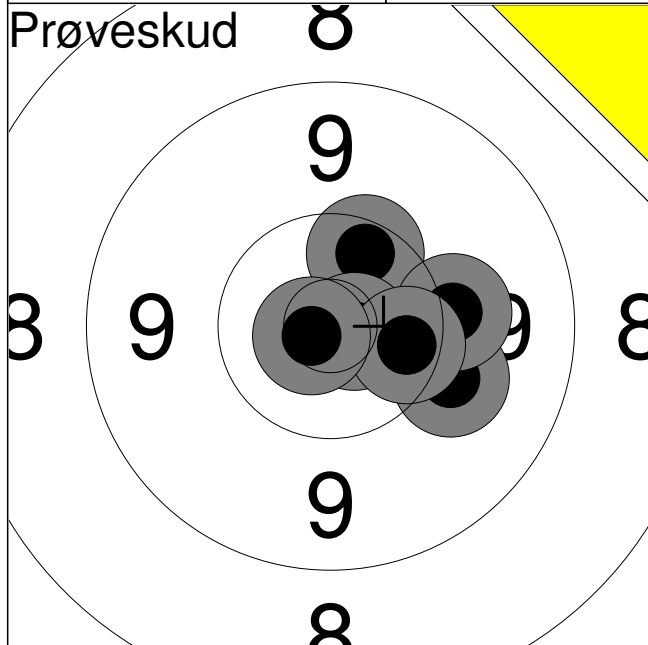

| | | |
|----|-------|---|
| 1: | 10.0 | → |
| 2: | 10.4 | ↑ |
| 3: | 10.1 | → |
| 4: | *10.8 | → |
| 5: | 10.4 | → |
| 6: | *10.8 | ↙ |

| | |
|-------|------|
| Serie | 60.0 |
| Total | 0.0 |

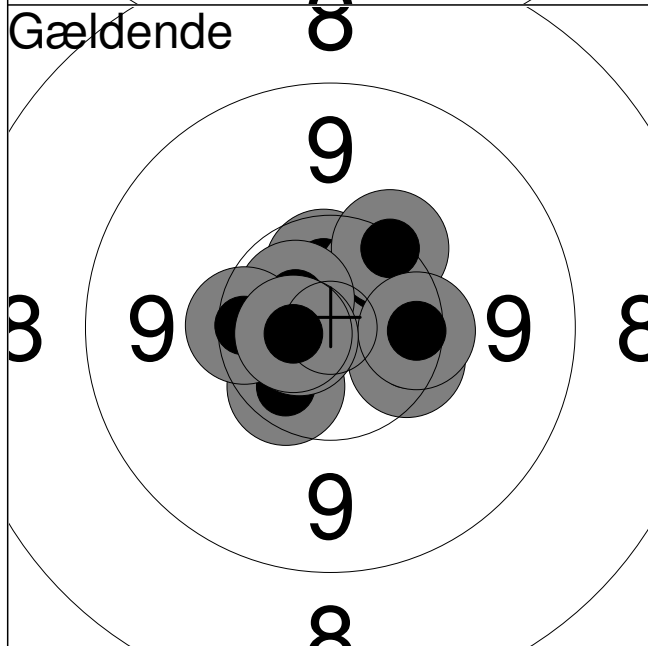

| | | |
|-----|-------|---|
| 1: | *10.4 | ↙ |
| 2: | *10.5 | ↑ |
| 3: | *10.5 | ↗ |
| 4: | 10.2 | ↗ |
| 5: | 10.4 | → |
| 6: | 10.3 | → |
| 7: | *10.6 | ↗ |
| 8: | 10.3 | ← |
| 9: | *10.7 | ← |
| 10: | *10.7 | ← |

| | |
|-------|-------|
| Serie | 100.0 |
| Total | 100.0 |

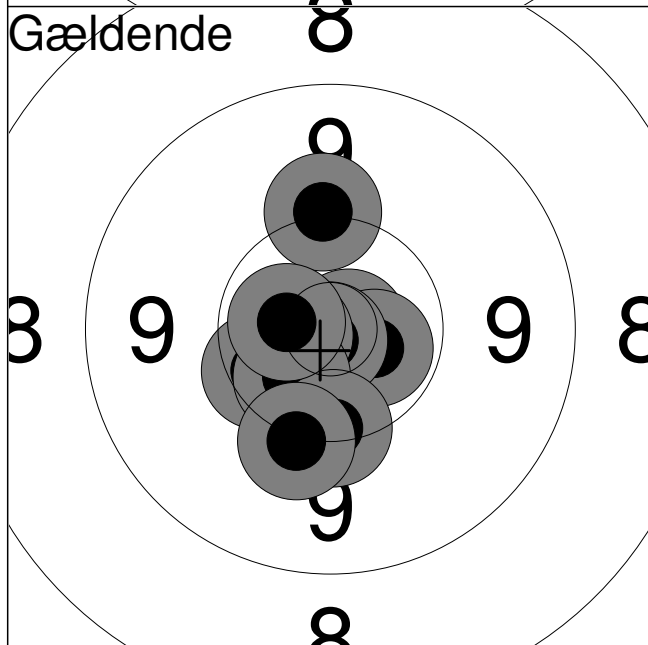

| | | |
|-----|-------|---|
| 11: | *10.8 | → |
| 12: | 10.4 | ↙ |
| 13: | *10.6 | → |
| 14: | *10.9 | ↓ |
| 15: | *10.7 | ← |
| 16: | *10.5 | ↙ |
| 17: | 10.3 | ↓ |
| 18: | 10.1 | ↙ |
| 19: | 10.1 | ↑ |
| 20: | *10.6 | ← |

| | |
|-------|-------|
| Serie | 100.0 |
| Total | 200.0 |

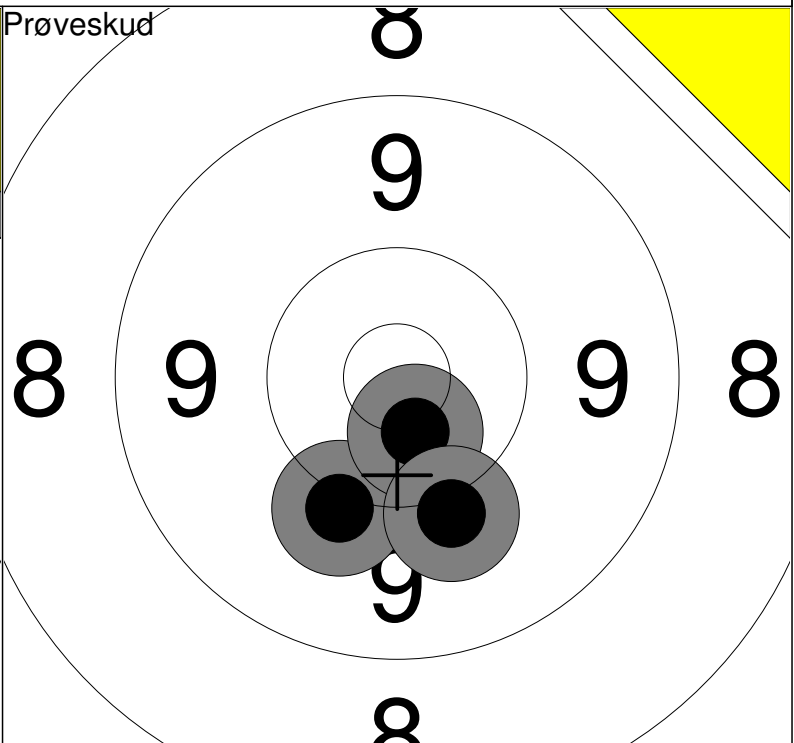
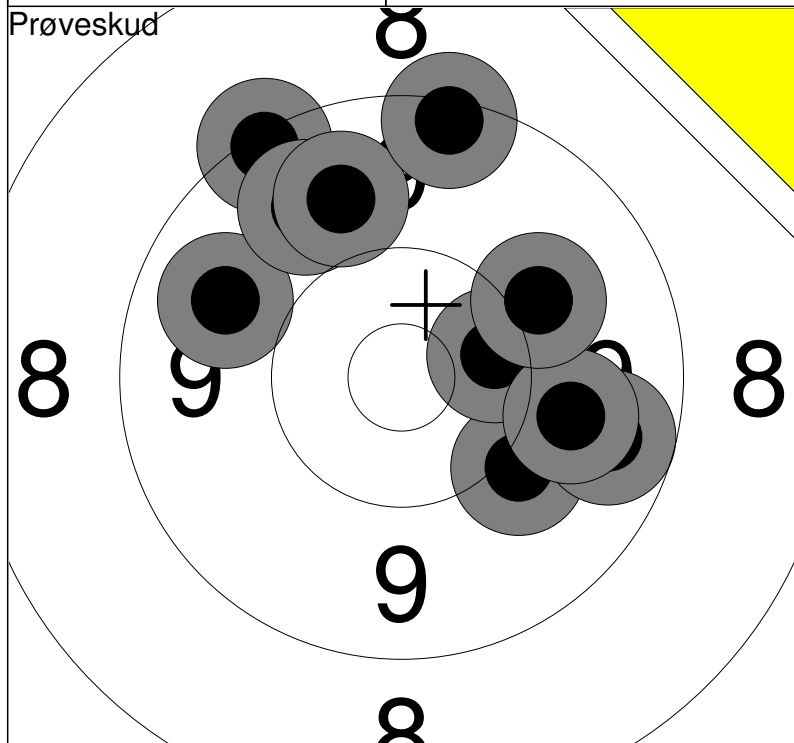

| | | | |
|-----------|-----------|-------|----|
| 1: 10.0 ↘ | 6: 9.8 ↗ | Serie | 93 |
| 2: 10.4 → | 7: 9.3 ↗ | | |
| 3: 9.6 → | 8: 9.7 ↗ | Total | 0 |
| 4: 9.9 → | 9: 9.8 ↗ | | |
| 5: 10.0 ↗ | 10: 9.3 ↗ | | |

| | | |
|-------------|-------|----|
| 11: 10.1 ↘ | Serie | 30 |
| 12: *10.6 ↘ | | |
| 13: 10.1 ↘ | Total | 0 |

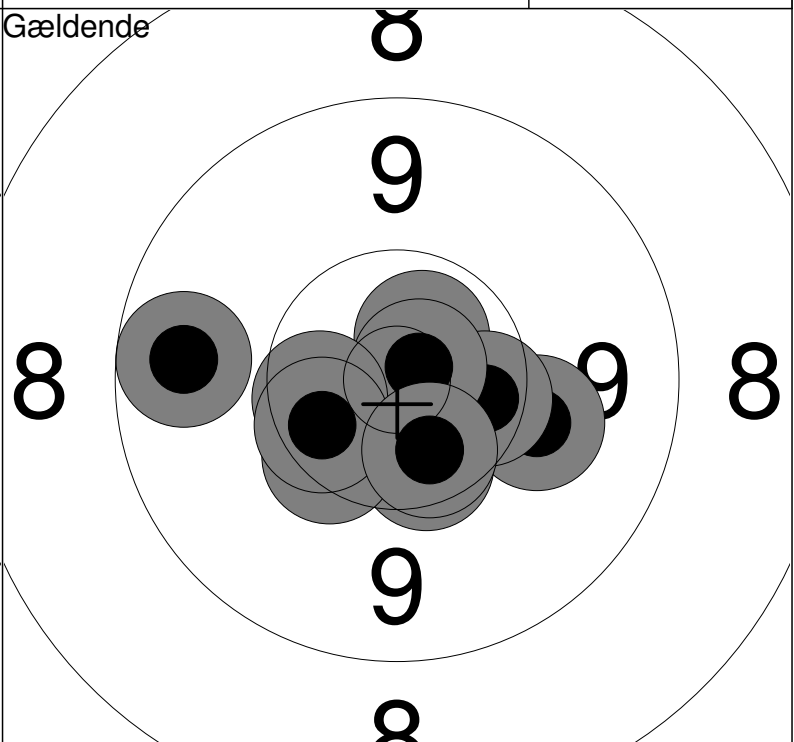
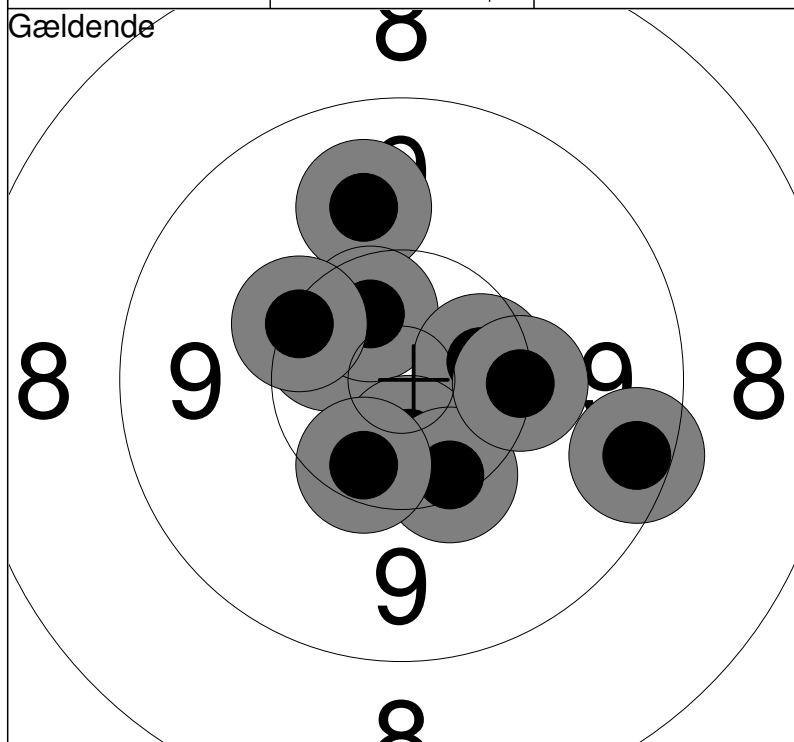

| | | | |
|------------|------------|-------|----|
| 1: 9.9 ↗ | 6: *10.6 ↘ | Serie | 98 |
| 2: *10.5 ↖ | 7: 10.3 ↘ | | |
| 3: *10.5 ↗ | 8: 9.4 → | Total | 98 |
| 4: *10.5 → | 9: 10.2 → | | |
| 5: 10.2 ↖ | 10: 10.4 ↘ | | |

| | | | |
|-------------|-------------|-------|-----|
| 11: 10.1 → | 16: 10.3 ↘ | Serie | 99 |
| 12: *10.7 ↗ | 17: *10.5 ← | | |
| 13: 10.4 → | 18: 9.6 ← | Total | 197 |
| 14: *10.8 ↗ | 19: *10.4 ← | | |
| 15: 10.4 ↘ | 20: *10.5 ↘ | | |



| | | |
|----|-------|---|
| 1: | *10.5 | ↘ |
| 2: | *10.5 | ↘ |
| 3: | 10.1 | ← |
| 4: | *10.6 | ↗ |
| 5: | *10.8 | → |
| 6: | *10.6 | ↘ |
| 7: | *10.7 | ↙ |

| | |
|-------|------|
| Serie | 70.0 |
|-------|------|

| | |
|-------|-----|
| Total | 0.0 |
|-------|-----|

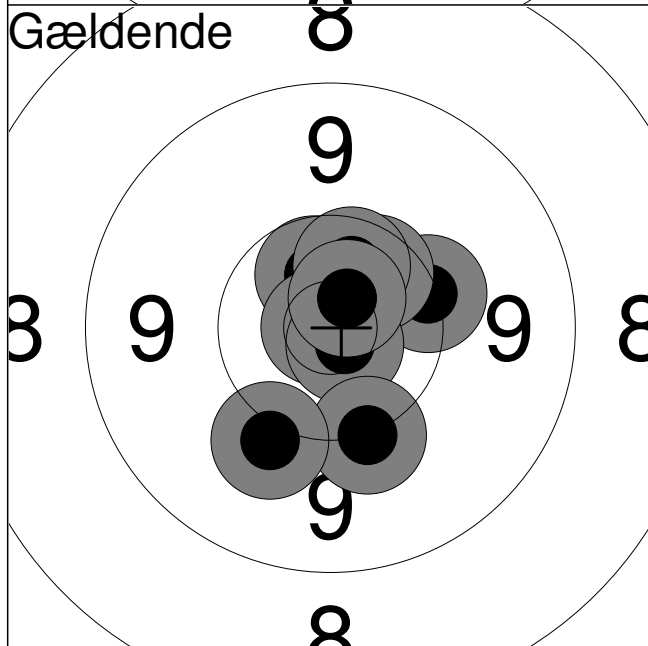

| | | |
|-----|-------|---|
| 1: | *10.7 | ↗ |
| 2: | *10.6 | ↗ |
| 3: | 10.2 | → |
| 4: | *10.5 | ↗ |
| 5: | *10.5 | ↗ |
| 6: | *10.9 | ← |
| 7: | *10.8 | ↘ |
| 8: | *10.7 | ↗ |
| 9: | 10.2 | ↘ |
| 10: | 10.1 | ↘ |

| | |
|-------|-------|
| Serie | 100.0 |
|-------|-------|

| | |
|-------|-------|
| Total | 100.0 |
|-------|-------|

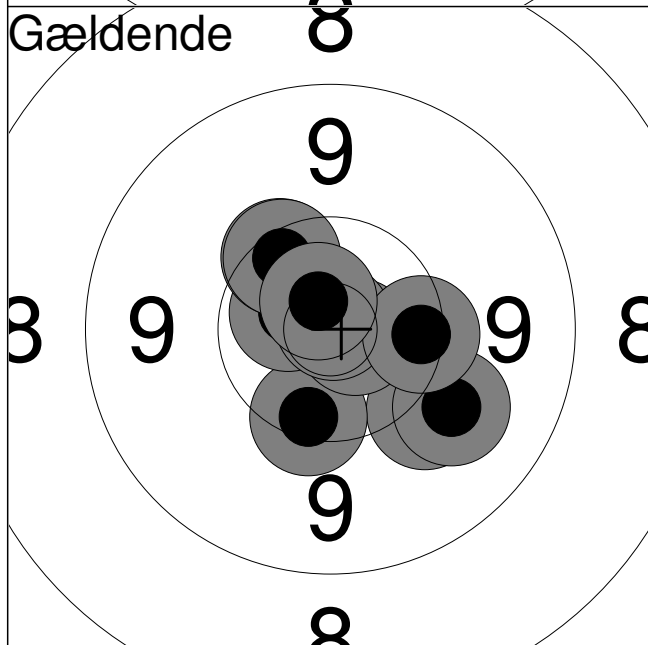

| | | |
|-----|-------|---|
| 11: | 10.1 | ↘ |
| 12: | 10.3 | ↘ |
| 13: | *10.6 | ↗ |
| 14: | 9.9 | ↘ |
| 15: | *10.8 | ↘ |
| 16: | *10.9 | ↗ |
| 17: | 10.3 | → |
| 18: | 10.3 | ↗ |
| 19: | 10.3 | ↗ |
| 20: | *10.7 | ↗ |

| | |
|-------|------|
| Serie | 99.0 |
|-------|------|

| | |
|-------|-------|
| Total | 199.0 |
|-------|-------|

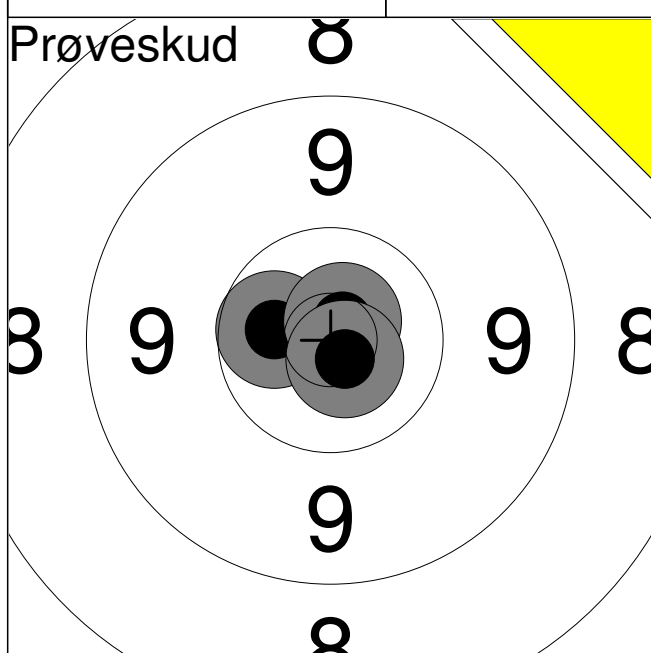

| | | |
|--------------|-------|-------------|
| 1: | *10.5 | ← |
| 2: | *10.8 | ↗ |
| 3: | *10.8 | ↘ |
| Serie | | 30.0 |
| Total | | 0.0 |

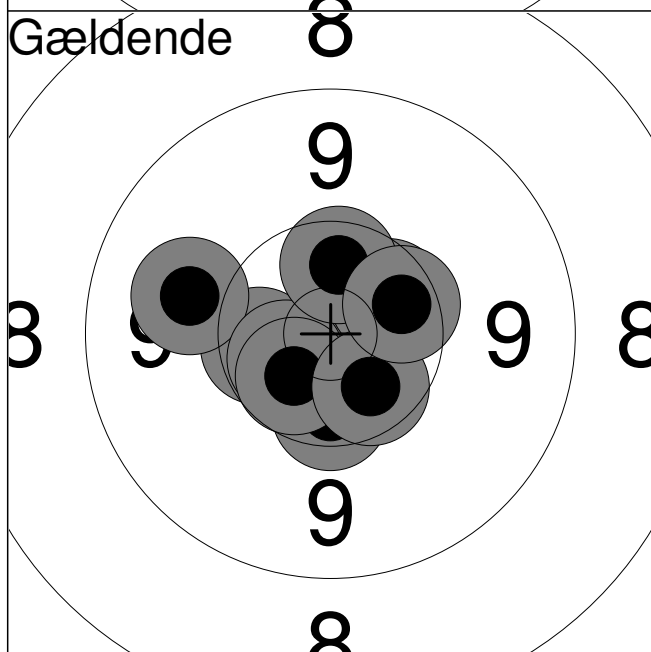

| | | |
|--------------|-------|-------------|
| 1: | *10.6 | ↓ |
| 2: | 10.4 | ↓ |
| 3: | *10.4 | ← |
| 4: | 9.9 | ← |
| 5: | *10.6 | ← |
| 6: | *10.6 | ↙ |
| 7: | *10.5 | ↗ |
| 8: | *10.5 | ↑ |
| 9: | *10.5 | ↘ |
| 10: | 10.4 | → |
| Serie | | 99.0 |
| Total | | 99.0 |

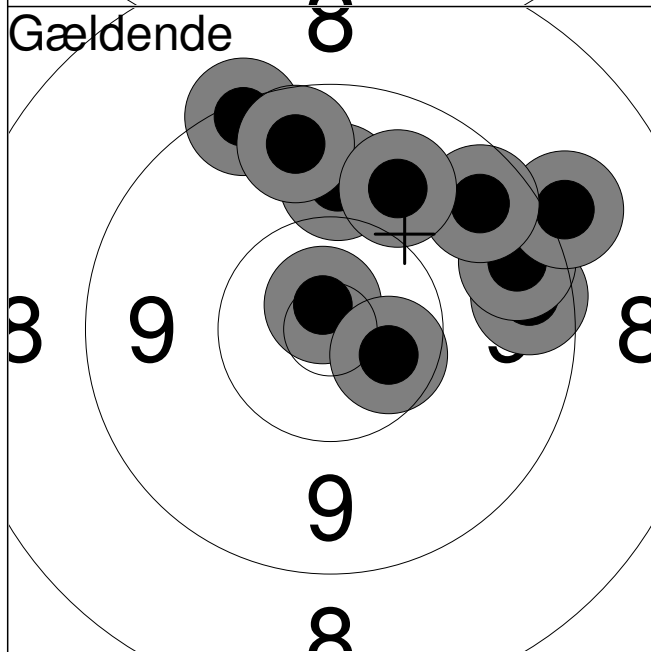

| | | |
|--------------|-------|--------------|
| 11: | 9.5 | → |
| 12: | 9.5 | → |
| 13: | 9.0 | ↗ |
| 14: | 9.5 | ↗ |
| 15: | 9.9 | ↑ |
| 16: | *10.8 | ↑ |
| 17: | 9.3 | ↑ |
| 18: | 9.6 | ↑ |
| 19: | 9.8 | ↗ |
| 20: | *10.5 | ↘ |
| Serie | | 92.0 |
| Total | | 191.0 |

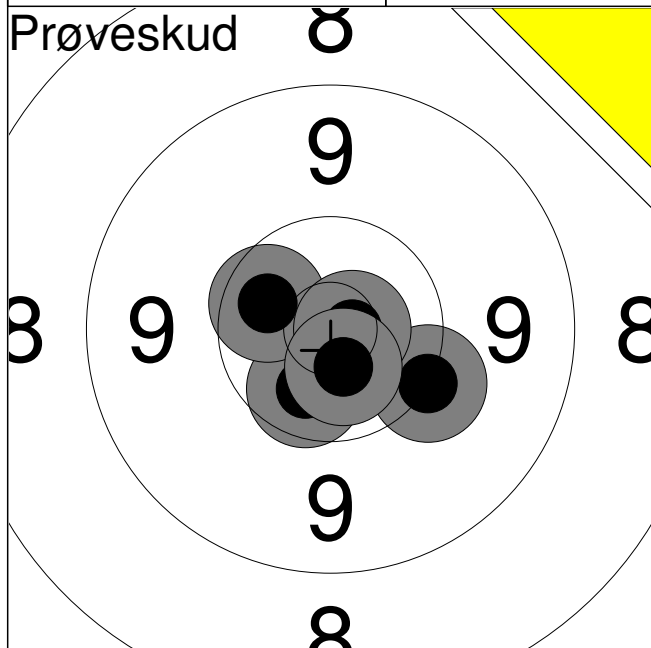

| | | |
|----|-------|---|
| 1: | 10.2 | ↘ |
| 2: | *10.5 | ↙ |
| 3: | *10.5 | ↗ |
| 4: | *10.8 | → |
| 5: | *10.7 | ↘ |

| | |
|-------|------|
| Serie | 50.0 |
| Total | 0.0 |

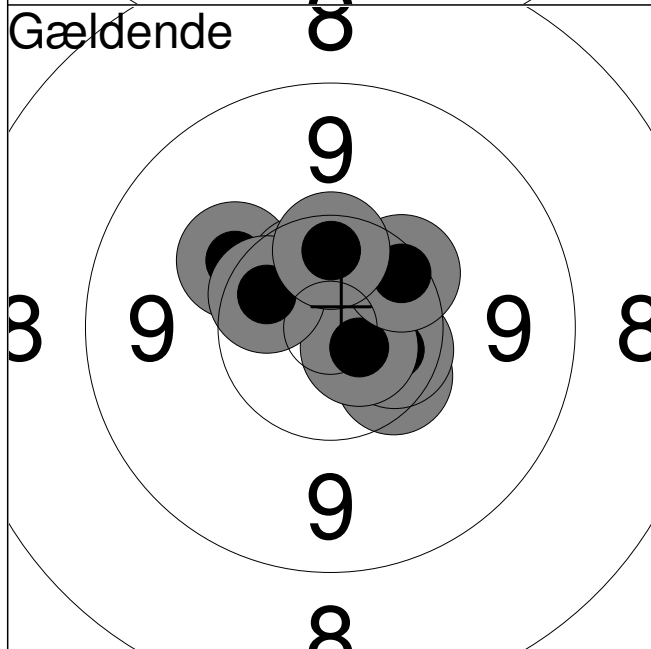

| | | |
|-----|-------|---|
| 1: | 10.4 | ↘ |
| 2: | 10.1 | ↗ |
| 3: | *10.5 | ↗ |
| 4: | *10.5 | ↗ |
| 5: | *10.5 | ↘ |
| 6: | *10.7 | ↗ |
| 7: | *10.7 | ↘ |
| 8: | *10.4 | ↗ |
| 9: | 10.3 | ↗ |
| 10: | 10.4 | ↑ |

| | |
|-------|-------|
| Serie | 100.0 |
| Total | 100.0 |

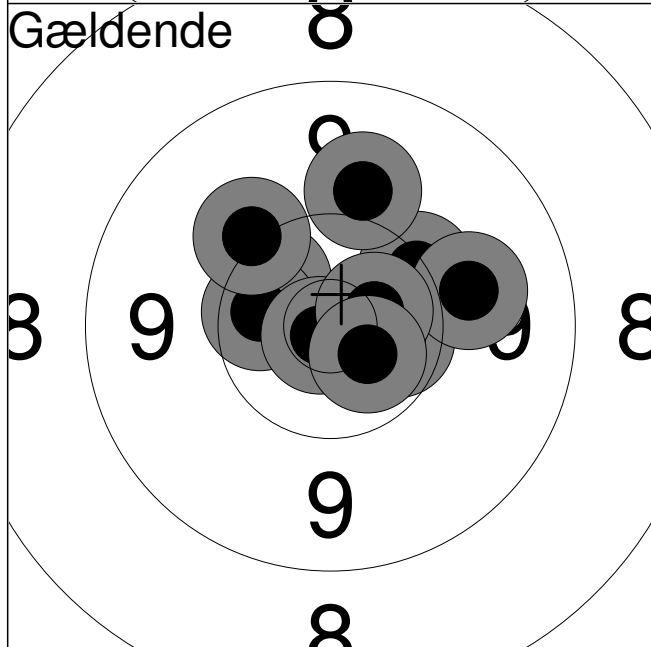

| | | |
|-----|-------|---|
| 11: | *10.4 | ↗ |
| 12: | 10.2 | ↗ |
| 13: | *10.4 | ← |
| 14: | *10.9 | ↙ |
| 15: | 10.0 | ↑ |
| 16: | *10.5 | → |
| 17: | 9.9 | → |
| 18: | 10.1 | ↗ |
| 19: | *10.6 | → |
| 20: | *10.6 | ↘ |

| | |
|-------|-------|
| Serie | 99.0 |
| Total | 199.0 |

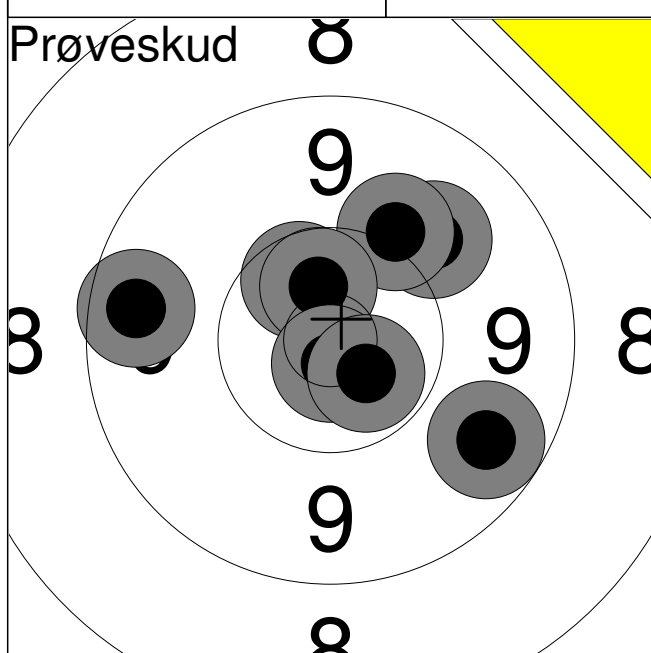

| | | |
|----|-------|---|
| 1: | 9.6 | ↘ |
| 2: | 9.5 | ↖ |
| 3: | 9.9 | ↗ |
| 4: | *10.5 | ↗ |
| 5: | 10.1 | ↗ |
| 6: | *10.6 | ↗ |
| 7: | *10.8 | ↘ |
| 8: | *10.6 | ↘ |

| | |
|-------|------|
| Serie | 77.0 |
| Total | 0.0 |

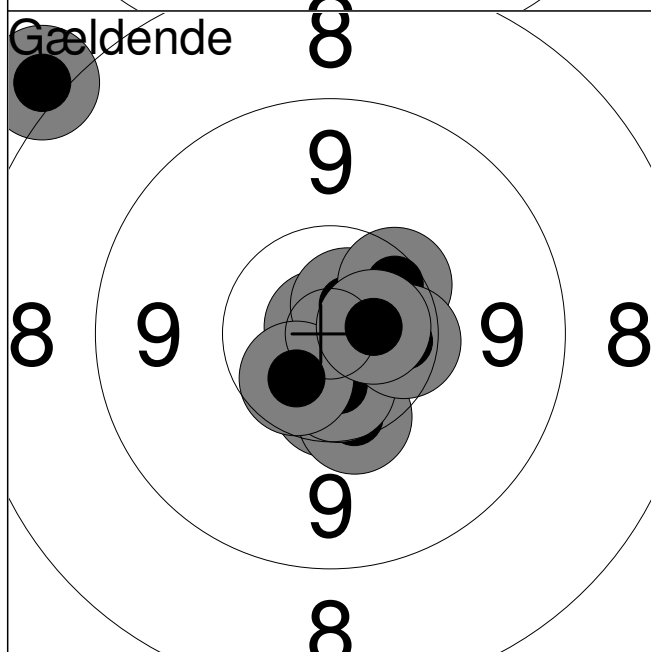

| | | |
|-----|-------|---|
| 1: | *10.5 | ↓ |
| 2: | *10.9 | ↗ |
| 3: | 10.3 | ↓ |
| 4: | *10.7 | ↗ |
| 5: | 8.0 | ↗ |
| 6: | *10.6 | ↓ |
| 7: | *10.5 | ↙ |
| 8: | 10.4 | ↗ |
| 9: | *10.4 | → |
| 10: | *10.6 | → |

| | |
|-------|------|
| Serie | 98.0 |
| Total | 98.0 |

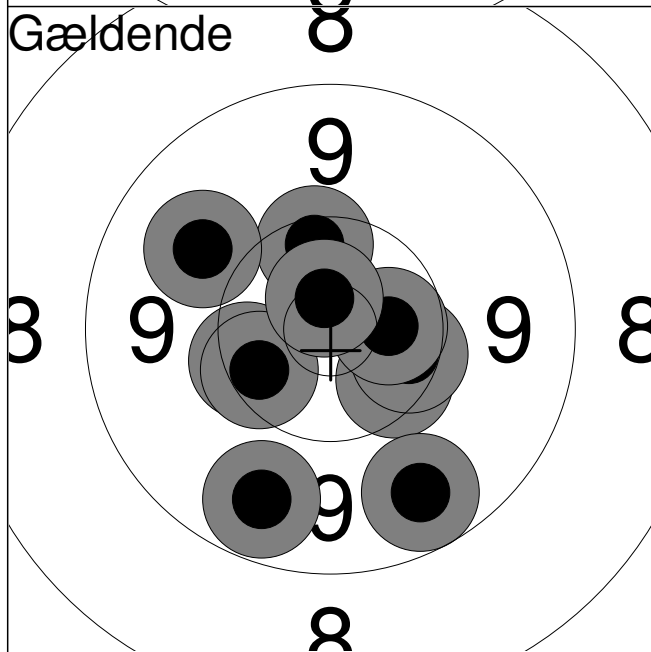

| | | |
|-----|-------|---|
| 11: | 10.3 | ← |
| 12: | 10.4 | ← |
| 13: | 10.4 | ↘ |
| 14: | 10.4 | → |
| 15: | *10.5 | → |
| 16: | 10.3 | ↗ |
| 17: | *10.7 | ↗ |
| 18: | 9.6 | ↘ |
| 19: | 9.6 | ↙ |
| 20: | 9.9 | ↗ |

| | |
|-------|-------|
| Serie | 97.0 |
| Total | 195.0 |

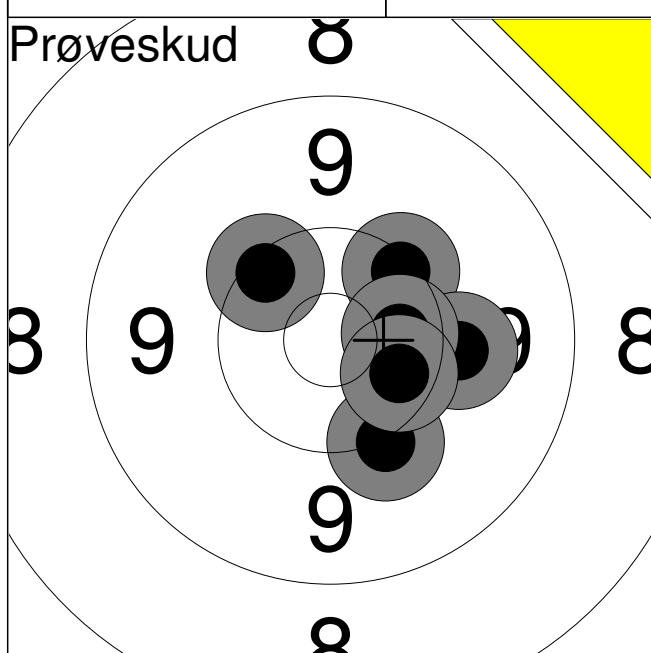

| | | |
|----|-------|---|
| 1: | 10.1 | ↘ |
| 2: | 10.3 | ↗ |
| 3: | 10.0 | → |
| 4: | 10.3 | ↗ |
| 5: | *10.5 | → |
| 6: | 10.4 | ↘ |

| | |
|-------|------|
| Serie | 60.0 |
| Total | 0.0 |

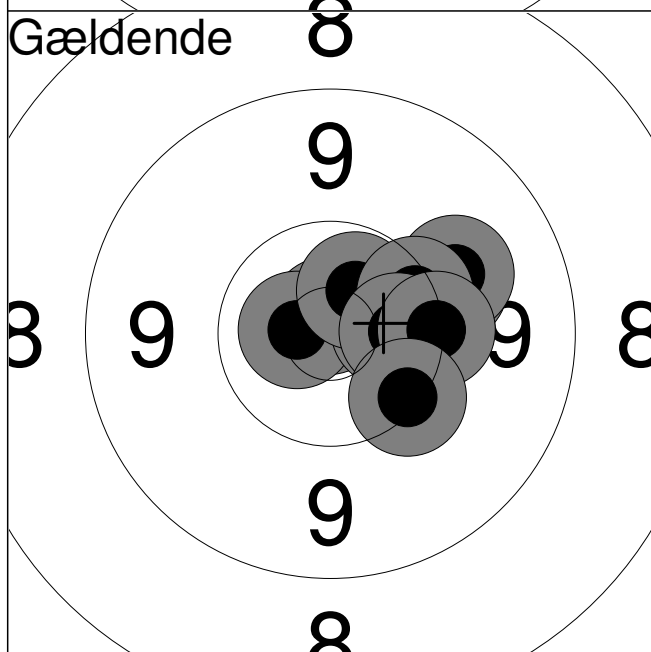

| | | |
|-----|-------|---|
| 1: | *10.8 | ↑ |
| 2: | 10.1 | → |
| 3: | 10.0 | → |
| 4: | *10.7 | ← |
| 5: | *10.5 | → |
| 6: | *10.6 | ↗ |
| 7: | 10.3 | → |
| 8: | *10.5 | → |
| 9: | 10.2 | → |
| 10: | 10.3 | ↘ |

| | |
|-------|-------|
| Serie | 100.0 |
| Total | 100.0 |

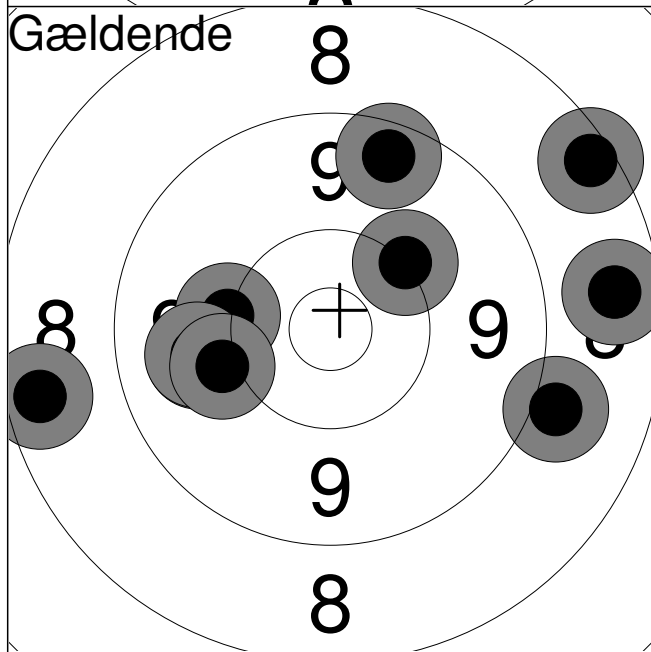

| | | |
|-----|------|---|
| 11: | 9.0 | → |
| 12: | 8.6 | → |
| 13: | 8.5 | ← |
| 14: | 10.1 | ← |
| 15: | 8.4 | ↗ |
| 16: | 9.9 | ← |
| 17: | 9.9 | ← |
| 18: | 9.5 | ↑ |
| 19: | 10.0 | ← |
| 20: | 10.2 | ↗ |

| | |
|-------|-------|
| Serie | 90.0 |
| Total | 190.0 |

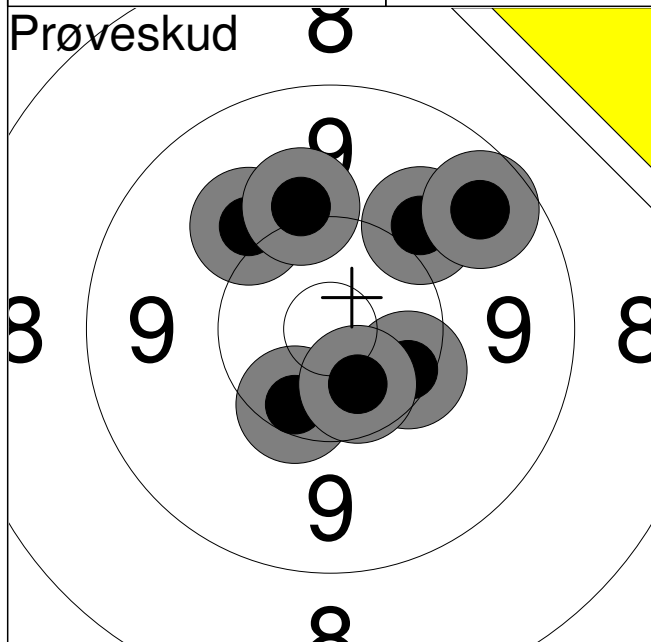

| | | |
|----|-------|---|
| 1: | 10.0 | ↗ |
| 2: | 10.0 | ↗ |
| 3: | 9.6 | ↗ |
| 4: | 10.1 | ↗ |
| 5: | 10.4 | ↘ |
| 6: | 10.3 | ↘ |
| 7: | *10.5 | ↘ |

| | |
|--------------|-------------|
| Serie | 69.0 |
| Total | 0.0 |

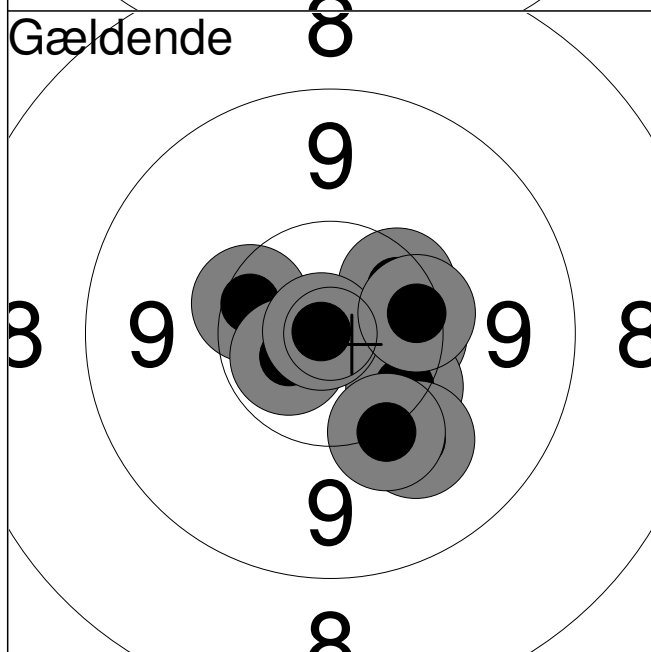

| | | |
|-----|-------|---|
| 1: | *10.7 | ← |
| 2: | 10.4 | → |
| 3: | 10.4 | ↗ |
| 4: | 10.3 | ↘ |
| 5: | 10.3 | ↗ |
| 6: | *10.6 | ← |
| 7: | 10.0 | ↘ |
| 8: | *10.9 | ↗ |
| 9: | 10.2 | ↘ |
| 10: | 10.3 | → |

| | |
|--------------|--------------|
| Serie | 100.0 |
| Total | 100.0 |

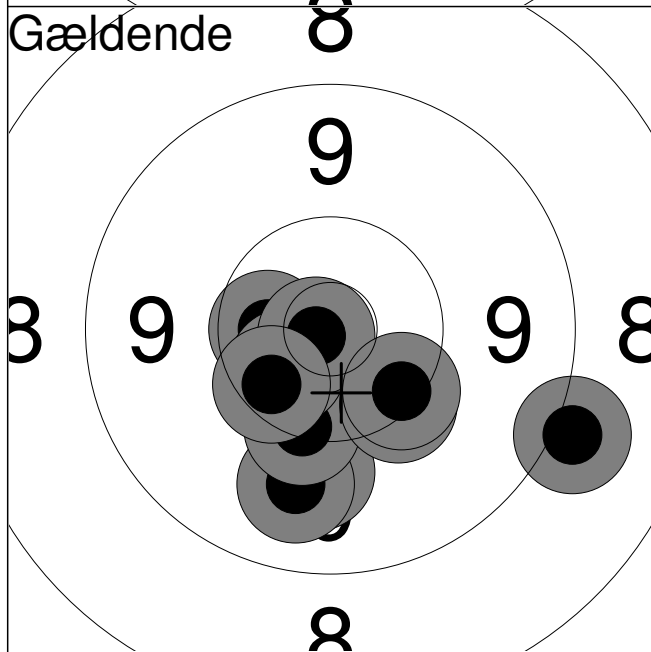

| | | |
|-----|-------|---|
| 11: | 9.9 | ↘ |
| 12: | *10.5 | ← |
| 13: | 9.8 | ↘ |
| 14: | 10.2 | ↘ |
| 15: | *10.5 | ← |
| 16: | *10.8 | ← |
| 17: | 9.0 | → |
| 18: | 10.4 | ← |
| 19: | 10.2 | ↘ |
| 20: | 10.3 | ↘ |

| | |
|--------------|--------------|
| Serie | 97.0 |
| Total | 197.0 |

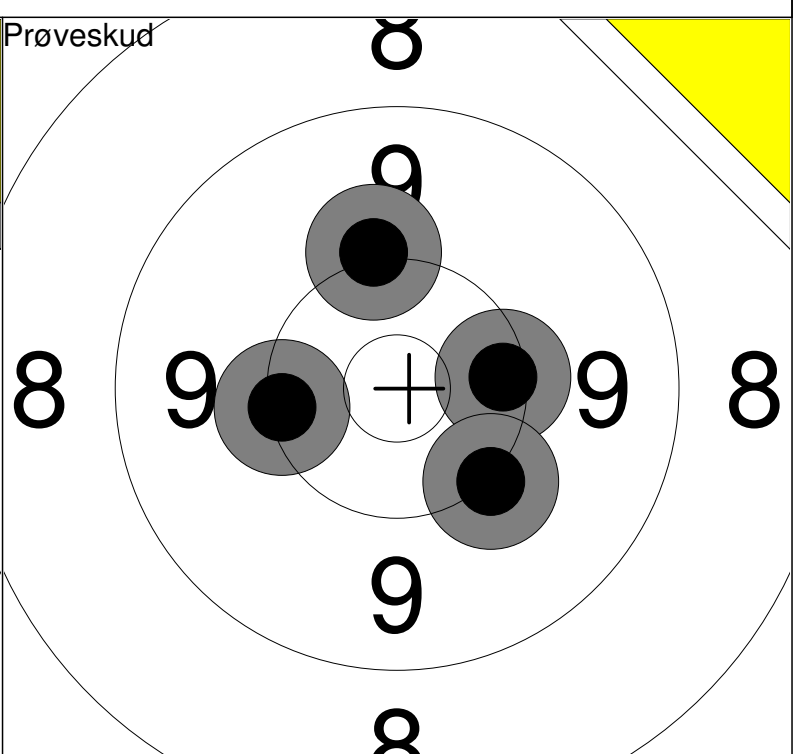
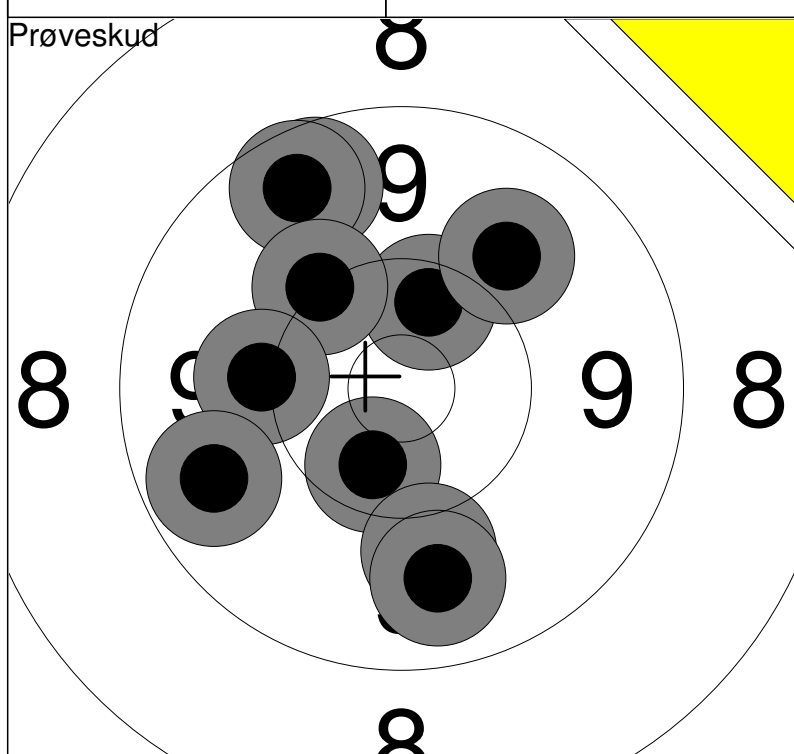

| | | | |
|-----------|------------|-------|----|
| 1: 9.6 ↗ | 6: 10.1 ← | Serie | 94 |
| 2: 9.5 ↗ | 7: *10.5 ↓ | | |
| 3: 10.4 ↗ | 8: 9.7 ← | Total | 0 |
| 4: 10.2 ↗ | 9: 9.9 ↓ | | |
| 5: 9.9 ↗ | 10: 9.8 ↓ | | |

| | | |
|------------|-------|----|
| 11: 10.2 ← | Serie | 40 |
| 12: 10.1 ↑ | | |
| 13: 10.3 → | Total | 0 |
| 14: 10.1 ↓ | | |

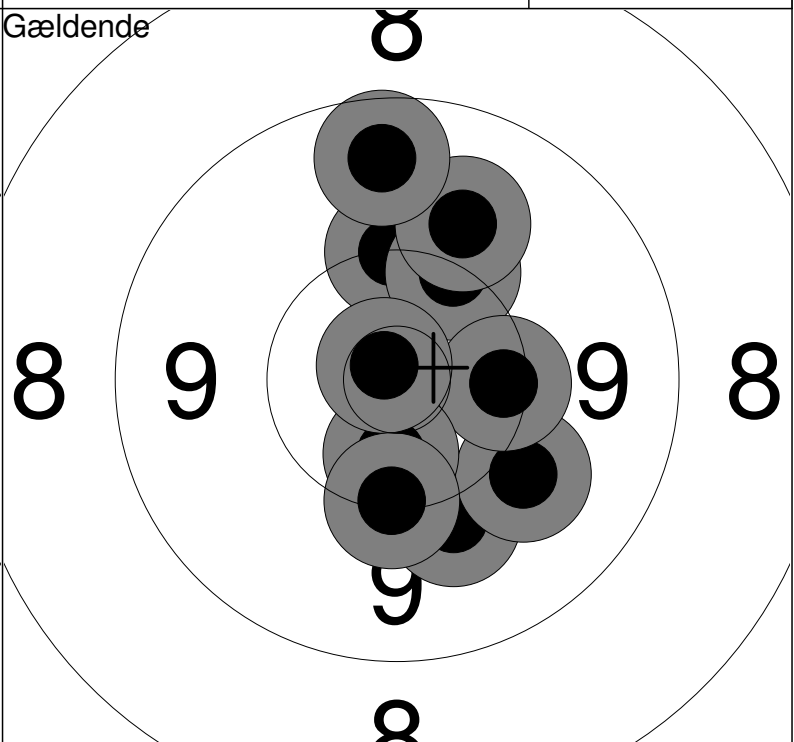
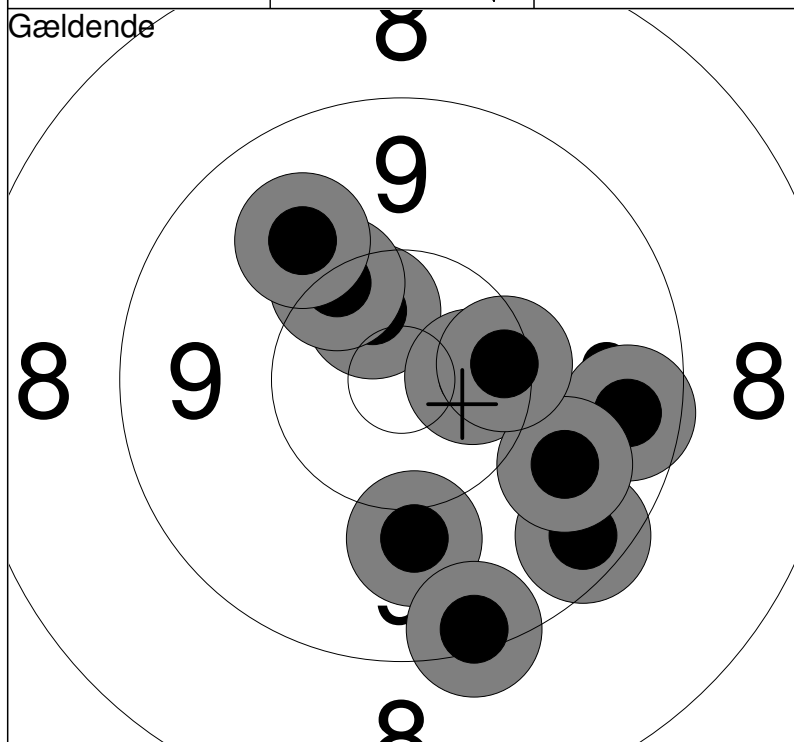

| | | | |
|------------|------------|-------|----|
| 1: 9.5 → | 6: 10.2 ↗ | Serie | 95 |
| 2: 10.0 ↓ | 7: 9.5 ↓ | | |
| 3: 9.3 ↓ | 8: 9.8 ↓ | Total | 95 |
| 4: *10.5 ↗ | 9: 9.9 ↗ | | |
| 5: *10.5 → | 10: 10.3 → | | |

| | | | |
|------------|-------------|-------|-----|
| 11: 10.0 ↓ | 16: 10.3 → | Serie | 98 |
| 12: 10.0 ↓ | 17: *10.5 ↓ | | |
| 13: 10.2 ↑ | 18: *10.8 ↖ | Total | 193 |
| 14: 10.2 ↗ | 19: 10.2 ↓ | | |
| 15: 9.9 ↗ | 20: 9.6 ↑ | | |

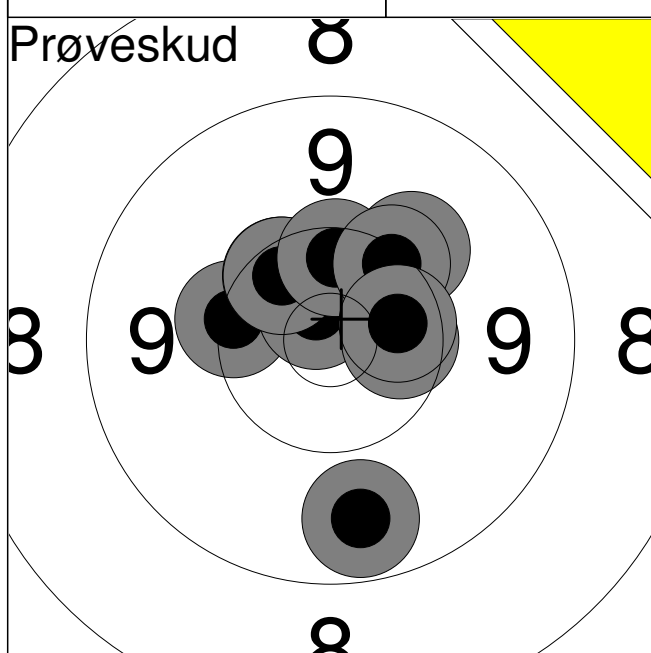

| | | |
|-----|-------|---|
| 1: | 10.3 | ← |
| 2: | 10.4 | ↗ |
| 3: | *10.7 | ↗ |
| 4: | 10.1 | ↗ |
| 5: | 10.4 | ↗ |
| 6: | 10.4 | ↑ |
| 7: | 10.3 | ↗ |
| 8: | 9.7 | ↓ |
| 9: | *10.5 | → |
| 10: | *10.5 | → |

| | |
|-------|------|
| Serie | 99.0 |
| Total | 0.0 |

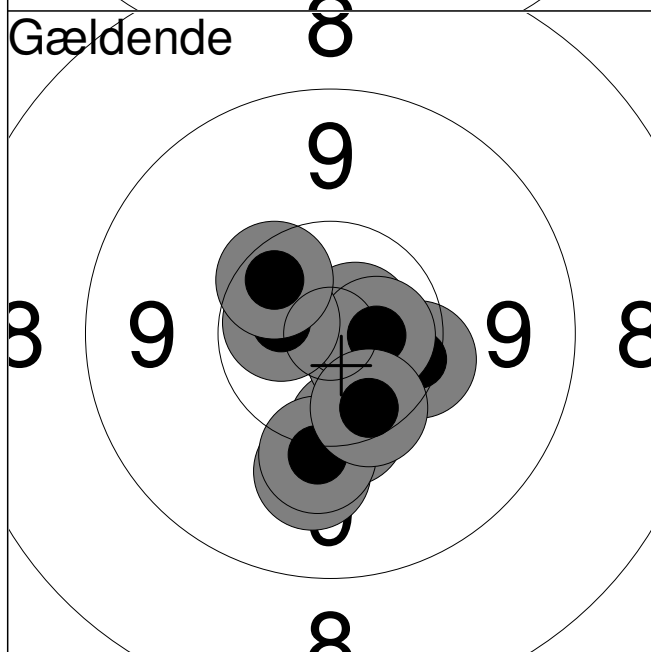

| | | |
|-----|-------|---|
| 1: | 10.3 | ↓ |
| 2: | *10.7 | ↘ |
| 3: | 10.3 | → |
| 4: | 10.0 | ↓ |
| 5: | *10.8 | ↗ |
| 6: | 10.1 | ↓ |
| 7: | *10.6 | → |
| 8: | *10.6 | ↖ |
| 9: | 10.4 | ↗ |
| 10: | 10.4 | ↓ |

| | |
|-------|-------|
| Serie | 100.0 |
| Total | 100.0 |

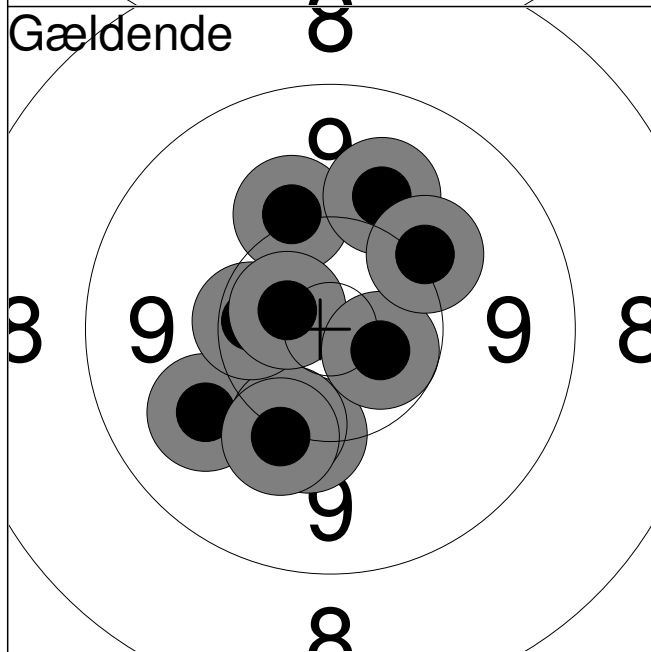

| | | |
|-----|-------|---|
| 11: | 10.2 | ↓ |
| 12: | 9.9 | ← |
| 13: | 10.2 | ↓ |
| 14: | 10.1 | ↓ |
| 15: | 10.1 | ↗ |
| 16: | 9.9 | ↗ |
| 17: | 10.4 | ← |
| 18: | *10.6 | ↖ |
| 19: | *10.6 | ↘ |
| 20: | 10.1 | ↗ |

| | |
|-------|-------|
| Serie | 98.0 |
| Total | 198.0 |

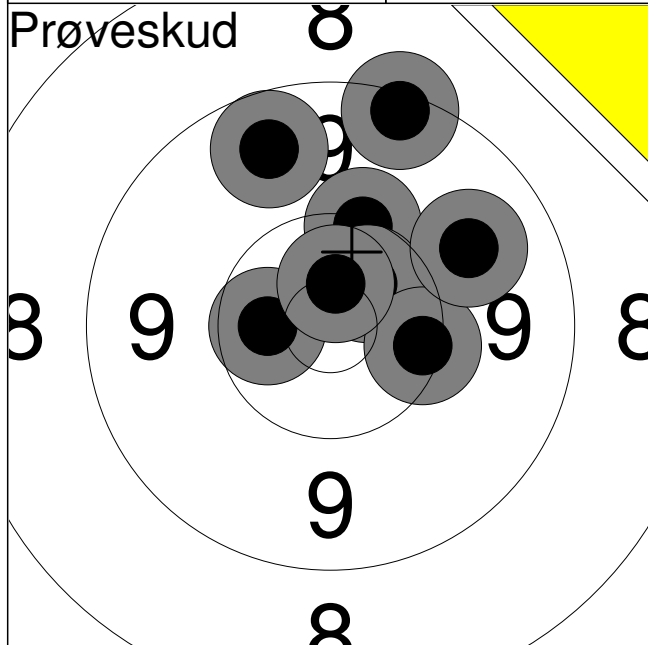

| | | |
|--------------|-------|-------------|
| 1: | *10.5 | ← |
| 2: | 10.2 | ↑ |
| 3: | *10.6 | ↗ |
| 4: | 10.3 | → |
| 5: | 9.3 | ↑ |
| 6: | 9.8 | ↗ |
| 7: | 9.6 | ↑ |
| 8: | *10.7 | ↑ |
| Serie | | 77.0 |
| Total | | 0.0 |

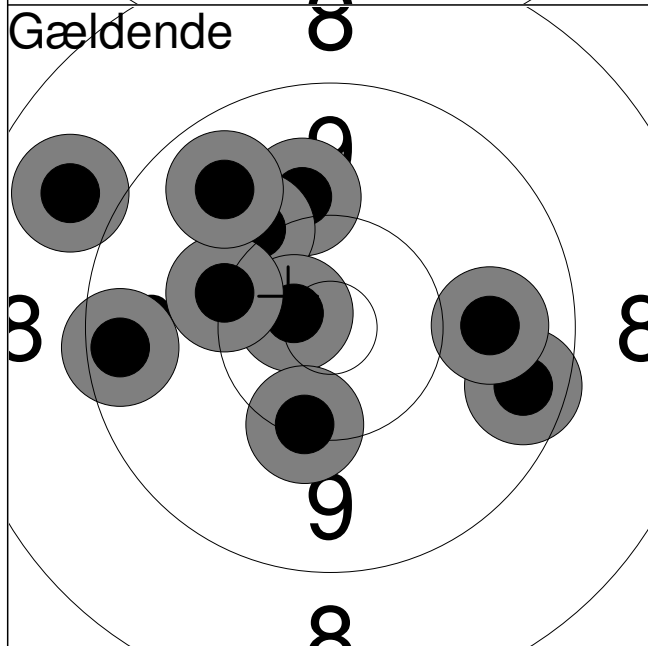

| | | |
|--------------|-------|-------------|
| 1: | 10.0 | ↑ |
| 2: | 9.5 | → |
| 3: | 9.8 | → |
| 4: | 10.1 | ↗ |
| 5: | *10.7 | ↑ |
| 6: | 10.2 | ↑ |
| 7: | 10.2 | ↓ |
| 8: | 9.7 | ↗ |
| 9: | 9.4 | ← |
| 10: | 8.8 | ↗ |
| Serie | | 94.0 |
| Total | | 94.0 |

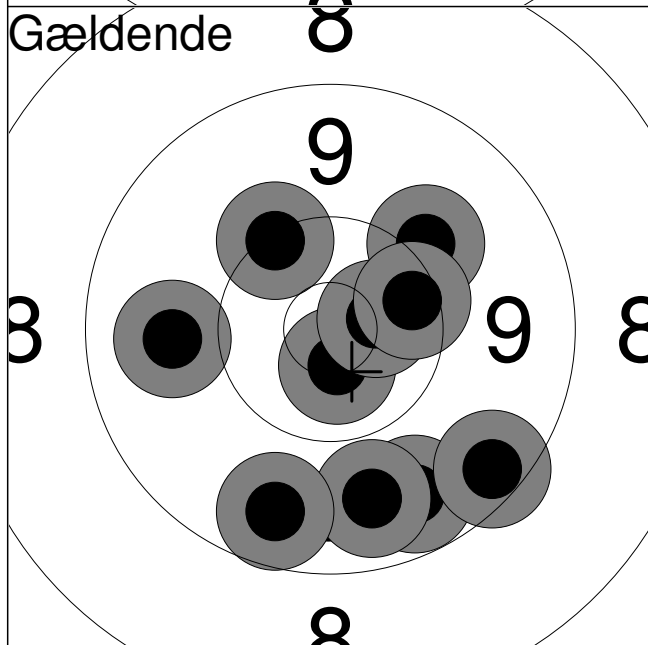

| | | |
|--------------|-------|--------------|
| 11: | 9.8 | ← |
| 12: | 9.6 | ↓ |
| 13: | 9.4 | ↓ |
| 14: | *10.7 | ↓ |
| 15: | 9.7 | ↓ |
| 16: | 9.6 | ↓ |
| 17: | *10.6 | → |
| 18: | 10.2 | ↗ |
| 19: | 10.1 | ↗ |
| 20: | 10.3 | → |
| Serie | | 95.0 |
| Total | | 189.0 |



| | | |
|----|-------|---|
| 1: | *10.6 | ↗ |
| 2: | 10.4 | ↑ |
| 3: | 10.3 | ↑ |
| 4: | *10.7 | ↑ |

| | |
|-------|------|
| Serie | 40.0 |
| Total | 0.0 |

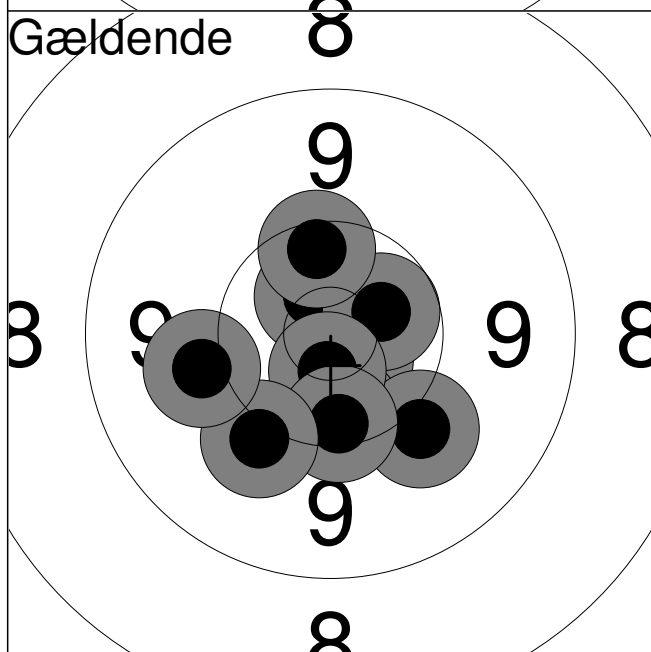

| | | |
|-----|-------|---|
| 1: | *10.7 | ↘ |
| 2: | *10.7 | ↑ |
| 3: | 10.4 | ↘ |
| 4: | *10.6 | → |
| 5: | 10.0 | ↘ |
| 6: | 10.3 | ↑ |
| 7: | *10.7 | ↘ |
| 8: | 10.3 | ↘ |
| 9: | 10.1 | ↘ |
| 10: | 10.0 | ← |

| | |
|-------|-------|
| Serie | 100.0 |
| Total | 100.0 |

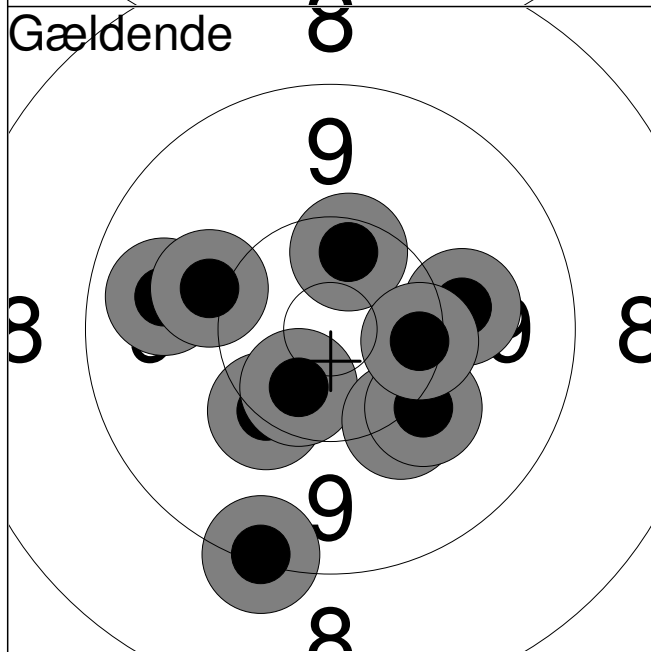

| | | |
|-----|-------|---|
| 11: | 10.2 | ↘ |
| 12: | 9.2 | ↘ |
| 13: | 9.7 | ← |
| 14: | 10.1 | ↑ |
| 15: | *10.5 | ↘ |
| 16: | 10.1 | ↘ |
| 17: | 10.0 | → |
| 18: | 10.4 | ↑ |
| 19: | 10.1 | ↘ |
| 20: | 10.3 | → |

| | |
|-------|-------|
| Serie | 98.0 |
| Total | 198.0 |